

BlueShadow

► Valves and valve drives Manual

V7695A



HPLC

Table of contents

Note: For your own safety, be sure to **read** the manual and **always** observe the warnings and safety information on the device and in the manual!

Intended use	6
Overview valves and valve drives	6
Multiposition valves	7
Injection valves	7
Connections of the ports at the positions <i>loading</i> and <i>injecting</i>	8
Series and operating modes	9
Laboratory use	10
Where is it prohibited to use the device or system?	10
Application examples	10
Selection of a column	11
Column selection with a 2-channel valve	12
Backflushing of a column	13
Backflushing of a precolumn	14
Accumulation of a sample	15
Precleaning of a sample by a precolumn	16
Precleaning of a sample	17
Alternating precleaning of a sample	18
Symbols and labels	20
Safety	21
Laboratory regulations	21
Solvents	21
PEEK connections	22
Protective measures	22
Power supply and mains connection	23
Target group	23
To what should the user pay particular attention?	23
What expertise should users have to safely operate a HPLC device or system?	23
Installation	24
Protective film on the screen	24
Scope of supply	24
Accessories	24
Checking the scope of delivery	24
Space requirements	25
Installation site	25
Front view of the device	25
Device display and buttons	25
Rear view of the device	26
Manual valves	26
Electrical valves	26

Mounting of the valve on the valve drive	27
Screw the adapter plate to the back side of the valve.	27
Screw the valve onto the valve drive	28
Mounting plate for valves and column holder	29
Connecting capillary with valve and seal	29
Inserting the needle seal in the syringe connection	30
Multifunction module 'Assistant'	31
Connection of the pump with other devices	32
Control of the pump with chromatography software	32
Local area network and automatic configuration	32
Interfaces for data transfer	32
Remote terminal strip	33
Operating the valves and valve drives	36
Switch-on and self-test	36
Display of the valve	36
Control of the valve with chromatography software	36
Operating the valve drive manually	36
The keyboard for operating the device	37
Setting the position of the valve	37
Set the position manually on the valve.	38
Filling the sample into the sample loop	38
Injecting the sample	39
Operating the valve drive externally	39
Analog control	39
Binary control	40
Connecting the flat ribbon cable with the connector strip	40
Connect valve drive to the devices <i>Manager</i> or <i>Interface Box</i>	41
Maintenance and care	44
Removing the valve	44
Alignment of the rotor seal in the valve	46
Insert new needle seal.	47
Increasing the pressure stability of valves	47
Cleaning and caring for the device	48
Environmental protection	48
Disposal	48
Decontamination.	48
Storage	48
Ambient storage conditions for the device	48
Troubleshooting	49

Technical data	50
Ambient conditions	50
Valve drive	50
Valve	51
Electrical valves	51
Manual valves	51
Abbreviations and terminology	52
Legal information	53
Warranty conditions	53
Manufacturer	53
Declaration of conformity	54
Table of Figures	55
Index	57

Intended use

HPLC High-pressure liquid chromatography (HPLC) is a method for separating substance mixtures, determining substances, and measuring their concentration.

The device or system is suitable for high-pressure liquid chromatography. It is suitable for laboratory use, for analyzing substance mixtures that can be dissolved in a solvent or solvent mixture.

**Injection valves,
multiposition valves,
and
electrical
valve drives**

Injection valves or multiposition valves are used in the HPLC to bring in the sample from the sample loop in the pump's high pressure flow, so that the sample is transported to the column. The sample is fed in at atmospheric pressure in the sample loop by a syringe or via feed pump from a sample reservoir.

Injection valves can have 2 or 3 channels, which depends on the rotor seal. Multiposition valves are 1-channel valves.

Overview valves and valve drives

Valves and valve drives are always completely assembled and tested when they leave the factory. The following components may be included:

Legend

- A. Mounting plate
- B. Valve drive
- C. Mounted, electrical injection valve
- D. Valve holder for pumps or detectors
- E. Electrical injection valve
- F. Hand injection valve

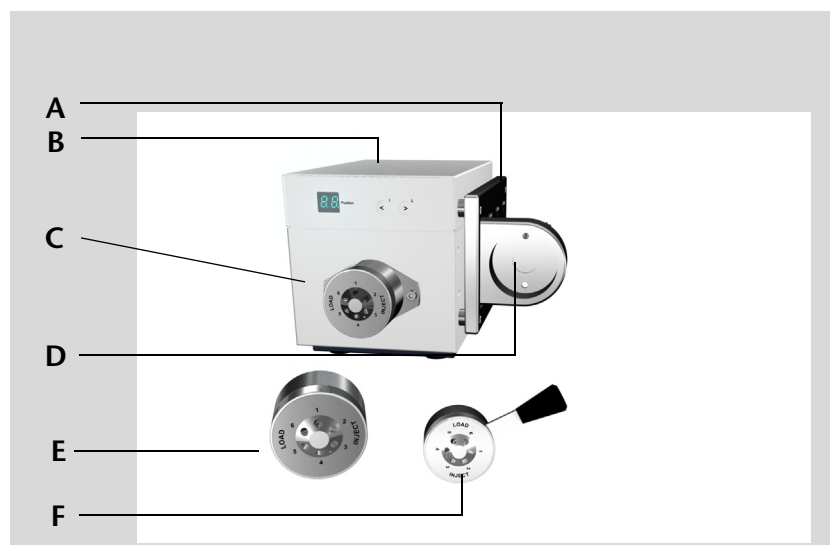

Fig. 1 Overview valves and valve drives

**Main areas of
application**

Main areas of application for multichannel valves are the injection or column switching, the column backflushing, sample accumulation, or the alternating sample accumulation. Multichannel valves are used for example to select different solvents (solvent selection valve) without having to reestablish the connections anew or laying out the capillaries again.

Single-channel valves are employed for fractioning if the form and the size of the fraction containers should be freely selectable. By combining a maximum of eight single-channel valve, up to 120 positions can be used for fractioning in applications in preparative HPLC.

Multiposition valves

Structure and function

The multiposition valve is used in chromatography, for example in the following cases:

- Selection of up to 13 different solvents
- Fractioning
- Column switching up to 16 columns

Legend

- A. Position number
- B. Connection between the central connection and the individual positions 1–6
- C. Adapter plate for mounting on the valve drive

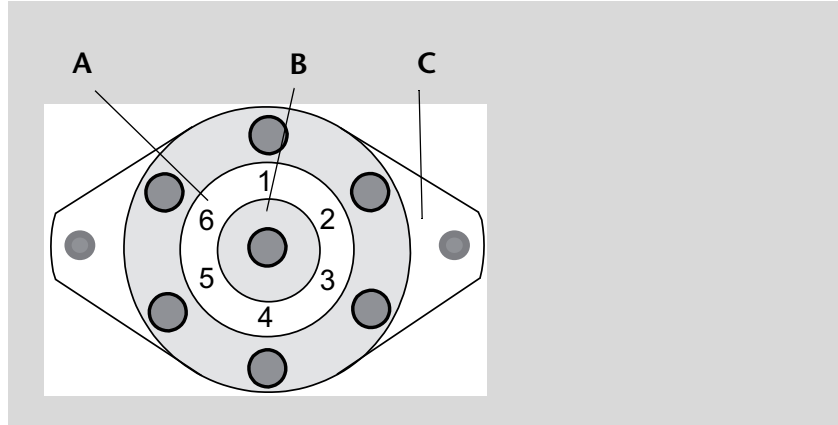

Fig. 2 Diagram of a multiposition valve 7P/1C

Injection valves

Versions

- 6 Ports with 3 channels
- 6 Ports with 2 channels

The structure of the rotor seal in the inside of the injection valve specifies whether the valve can be operated as a 2- or 3-channel valve.

Legend

- A. Position number
- B. 6 Ports with 2 channels (6P/2C)
- C. Adapter plate for mounting on the valve drive
- D. 6 Ports with 3 channels (6P/3C)

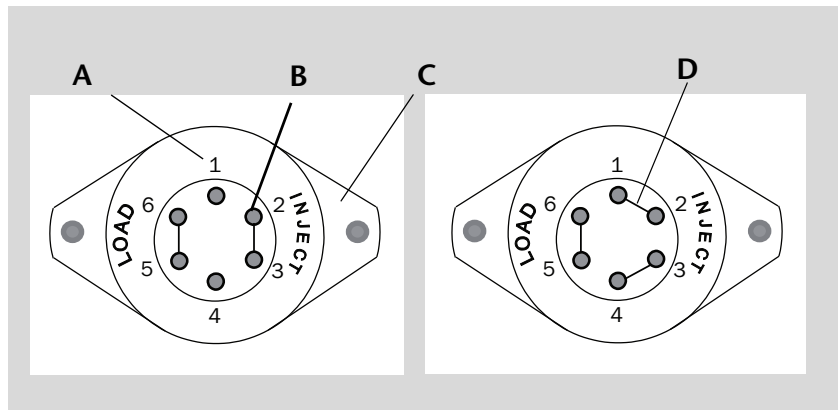

Fig. 3 Injection valves 6P/2C and 6P/3C

Connections of the ports at the positions *loading* and *injecting*

Valve position *Loading (L)* In the valve position *loading*, the sample is filled into the sample loop.

Valve position *Injecting (I)* In the valve position *injecting*, the sample is flushed for example on a precolumn or main column for pre-separation or separation.

The sample loop is filled, by injecting the sample at connection 1. This runs into the sample loop (connection 2 and 5) and excessive sample is transported into the waste container through connection 6.

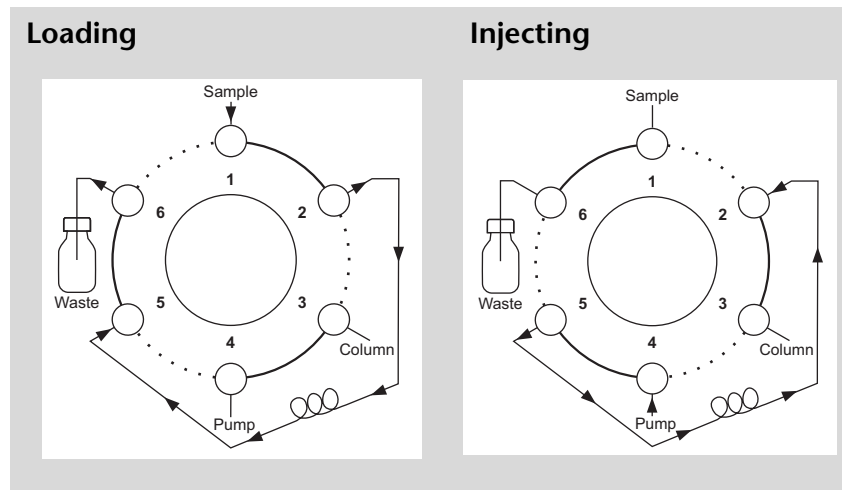

Fig. 4 Valve positions loading and injecting

The eluent flows through the sample loop in opposite direction during the injecting, see arrows in the figures.

Reed contact The reed contact in the injection or multiposition valve gives the start signal for a measurement to the entire analytical system or a detector.

Hand-operated valves For hand-operated valves, a mounting of a mounting plate or a universal angle on the housing of a valve drive is advisable.

Electrical valve drives Electrical valve drives for the injection or multiposition valves synchronize the sample injection in the analytical system. The valves are operated by a 24 V direct current motor. The electrical drive and the valve have been factory-set and can be modified by DIP switches (Dual In-line Package) on the bottom of the device for certain applications.

By means of chromatography software or a cable for remote control, certain positions can be controlled directly on a valve.

Delivery ex works All valve drives are delivered with a ready-mounted injection or multiposition valve.

Series and operating modes

The following valves fit to the listed valve drives:

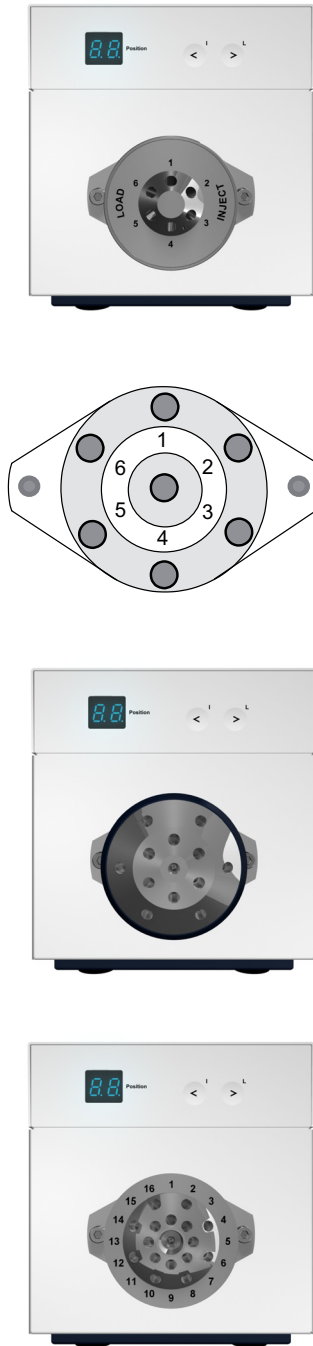

Valve	Switch positions	Operating mode
6V injection valve	2	6P/3C 6 ports/3 channels 6P/2C 6 ports/2 channels
6V Multiposition valve	6	7P/1C 7 ports/1 channel
12V Multiposition valve	12	13P/1C 13 ports/1 channel
16V Multiposition valve	16	16P/1C 16 ports/1 channel

Note: The possible combinations between valves and electrical drives can be queried by the technical support of the manufacturer.

**Room ventilation,
A/C system,
sunlight**

Always use the device in rooms that are well-ventilated, and are preferably equipped with an air-conditioning system. When setting up the system at the installation location, make sure that it is protected against direct sunlight.

Checking intended use

► Only use the device for applications that fall within the range of the intended use. Otherwise, the protective and safety equipment of the device could fail.

Laboratory use

- Biochemistry analyses
- Chemical analyses
- Food analyses
- Pharmaceutical analyses
- Environmental analyses

Where is it prohibited to use the device or system?



DANGER! Risk of explosion! Never use the device in potentially explosive atmospheres without appropriate protective equipment and approval by a notified body! Inform the technical service department of the manufacturer.

Application examples

Abbreviations

Connections and channels of an injection or multiposition valve are described by abbreviations.

Example 6P/3C valve: That is an injection valve with 6 connections (P = port) and 3 channels (C = channel).

6P/3C valves

- Selection of a column
- Backflushing of a column
- Backflushing of a precolumn
- Sample accumulation on a precolumn
- Alternating accumulation of a sample
- Alternating precleaning of a sample

6P/2C valves

- Preseparation and analyses on several columns after each other
- Sample precleaning by a precolumn

7P/1C valves

- Series switching of up to 16 columns
- Step gradient or selection of a eluent

Selection of a column

Basics The selection of a column, also called column selection, is used in chromatography, for example in the following cases:

- Method development
- Column selection

Injection From the injection valve, the sample is injected via the channel 2->1 onto the the column A. From connection 5, the components of the sample are forwarded separate to the detector.

Injecting on column A

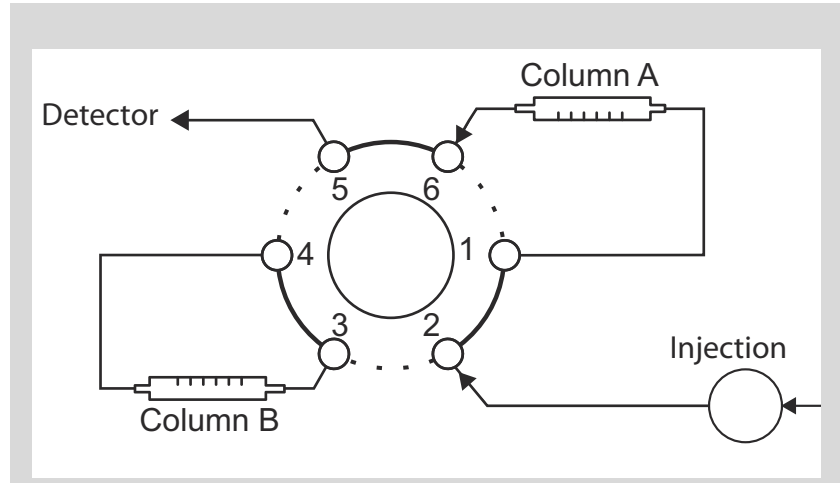

Fig. 5 Column selection – injection from the 6P/3C valve on column A

Note: Make sure there is no pressure when switching between the columns so that the columns are not damaged.

From the injection valve, the sample is injected via the channel 2->3 onto the column B. From connection 5, the components of the sample are forwarded separate to the detector.

Injecting on column B

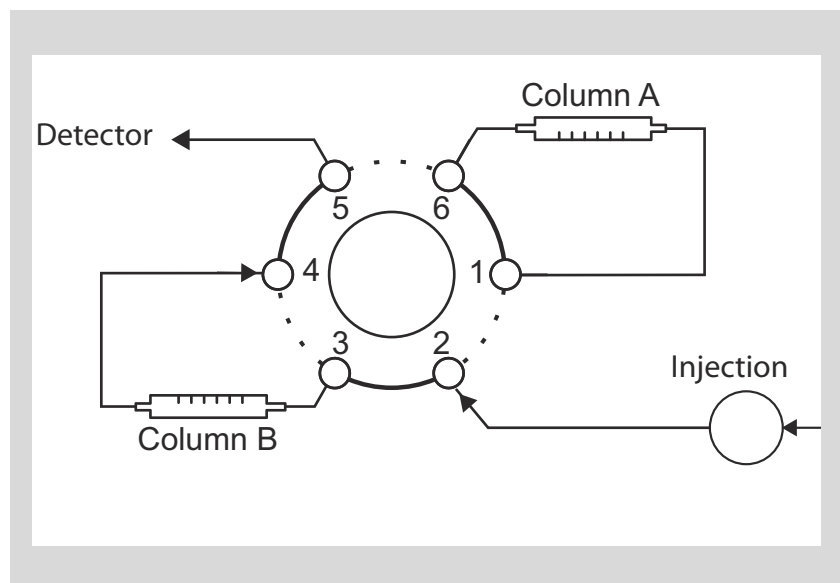

Fig. 6 Column selection – injection from the 6P/3C valve on column B

Column selection with a 2-channel valve

- Separation of the sample on the precolumn
- Separation of the sample components on different columns

The sample is separated on the precolumn. The further separation can be carried out on column 1 and be continued on column 2 after switching over.

Legend

- A. Detector
- B. Column 1
- C. Precolumn
- D. Injection valve
- E. Column 2

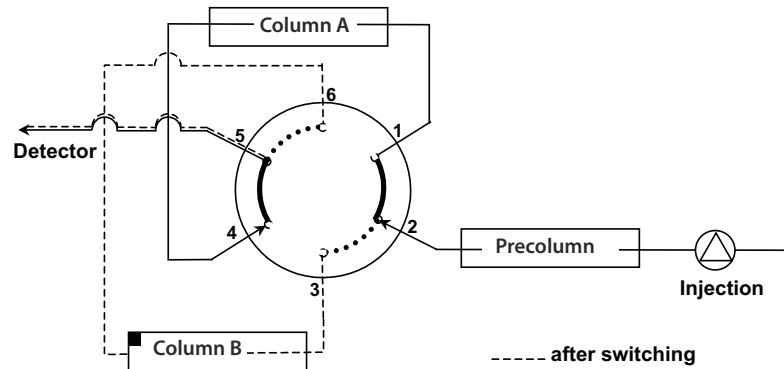

Fig. 7 Column selection with a 2-channel valve

Backflushing of a column

Basics The backflushing of a column is used in chromatography, for example in the following cases:

- Analysis of heavily retarding substances
- Optimization of analysis times
- Flushing of a column

Note: The eluent flushes the column after switchover in opposite direction (reduction of the band broadening).

From the injection valve, the column is filled with sample through the channel 2->3. The quicker part of the substances is separated through the channels 6->1 and 5->4 and flushed to the detector.

Injection

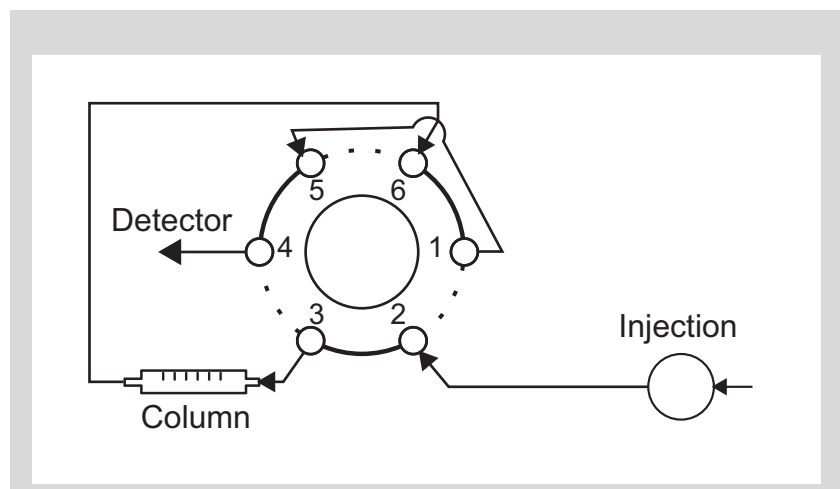

Fig. 8 Backflushing – injection from the 6P/3C valve on the column

Note: Make sure there is no pressure when switching between the columns so that the columns are not damaged.

After switching over the valve to the channel 2->1, heavily retarding substances are eluted in opposite direction fluid from the column and flushed back to the detector.

Switchover of the direction of flow

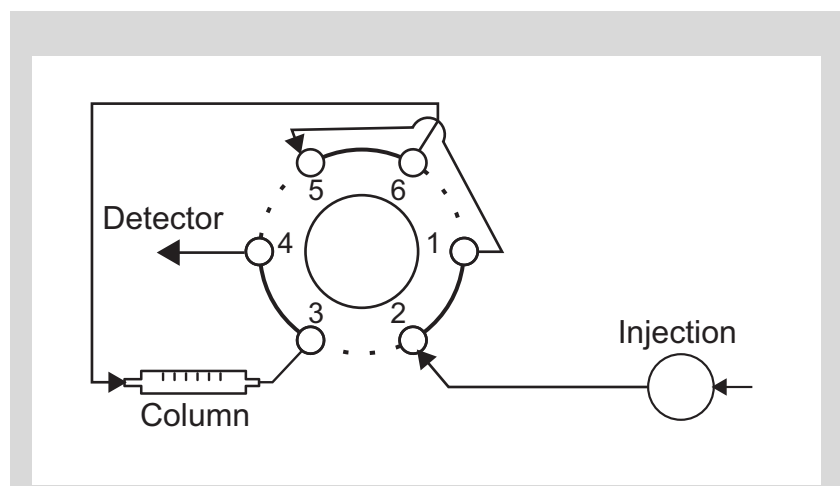

Fig. 9 Backflushing – switchover of the 6P/3C valve

Backflushing of a precolumn

Basics The precolumn is used in chromatography, for example in the following cases:

- Preseparation or separation of heavily retarding substances
- Protection of the main column

Note: Precolumn and main column are aligned in a row behind each other.

Injection on precolumn

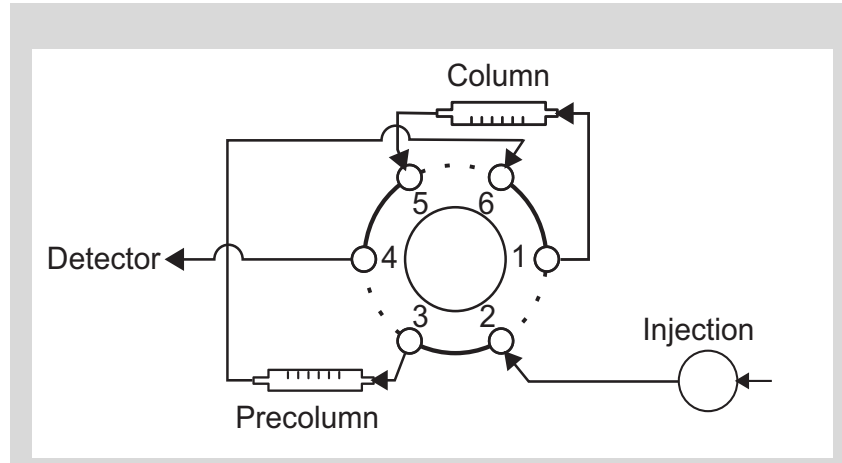

Fig. 10 Backflushing precolumn – injection from the 6P/3C valve on the precolumn

From the injection valve, the precolumn is filled with sample through the channel 2->3. From the channel 6->1, the quickly dissolved substances on the column are measured, the heavily retarding substances remain on the precolumn.

Note: The eluent flushes the precolumn after switchover in opposite direction.

Switchover of the direction of flow

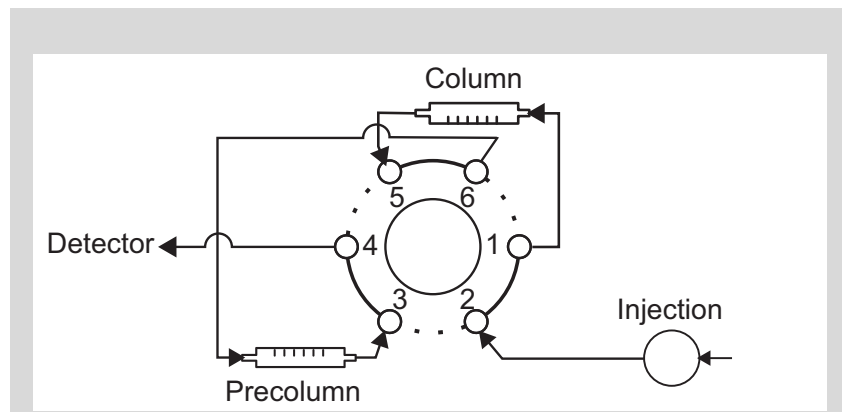

Fig. 11 Backflushing precolumn – switchover of the 6P/3C valve
After switching over the valve to the channel 2->1, the late eluting substances are flushed back in opposite direction from the precolumn to the detector.

Accumulation of a sample

Basics The accumulation of a sample is employed in chromatography, for example in the following case:

- Samples that are very diluted by solvents

Note: The solvent is fed through a detector A into the waste container. As soon as sufficient sample has been accumulated on the precolumn, the valve is switched over and the thus accumulated sample is flushed with a different solvent to the analytical column.

Injection on precolumn

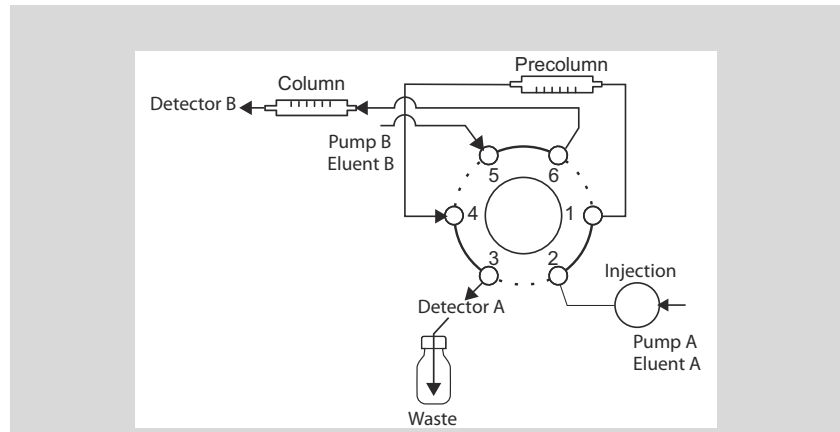

Fig. 12 Sample accumulation on precolumn – injection from the 6P/3C valve

From the injection valve, the precolumn is filled with solvent A through the channel 2- \rightarrow 1. From channel 4- \rightarrow 3, the eluent is fed through the detector A into the waste container.

Note: Make sure there is no pressure when switching between the columns so that the columns are not damaged.

After switching over the valve to the channel 5- \rightarrow 4, a solvent B are flushed back in opposite direction through the precolumn. The accumulated sample is flushed through channel 1- \rightarrow 6 onto the analytic column and measured with detector B.

Switchover of the direction of flow

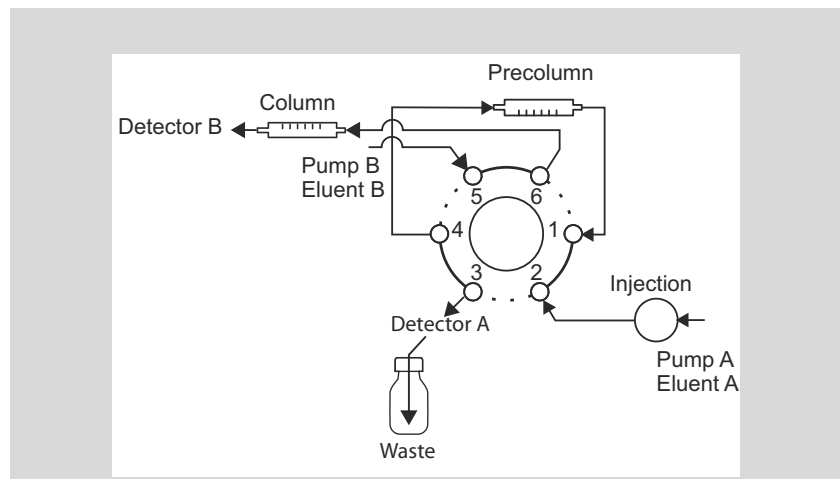

Fig. 13 Sample accumulation – analysis of the accumulated sample

Precleaning of a sample by a precolumn

Basics The precleaning of a sample is used in chromatography, for example in the following cases:

- Preseparation or separation of heavily retarding substances
- Precleaning samples, alternating and time-delayed on different precolumns

Injection on precolumn

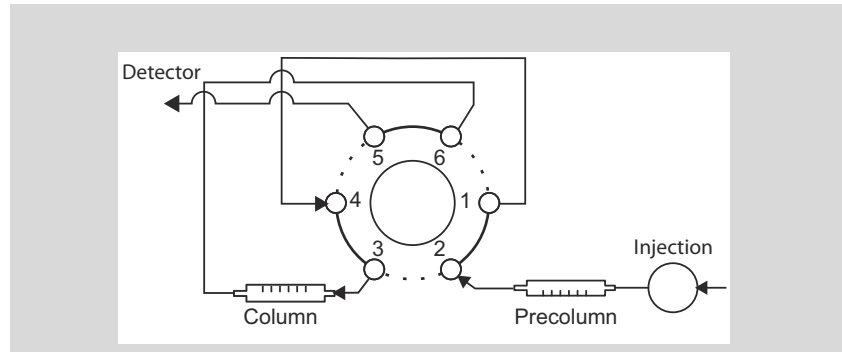

Fig. 14 Precleaning of a sample by a precolumn

After the injection of the sample on the precolumn, it is heavily retarded.

Switchover of the direction of flow

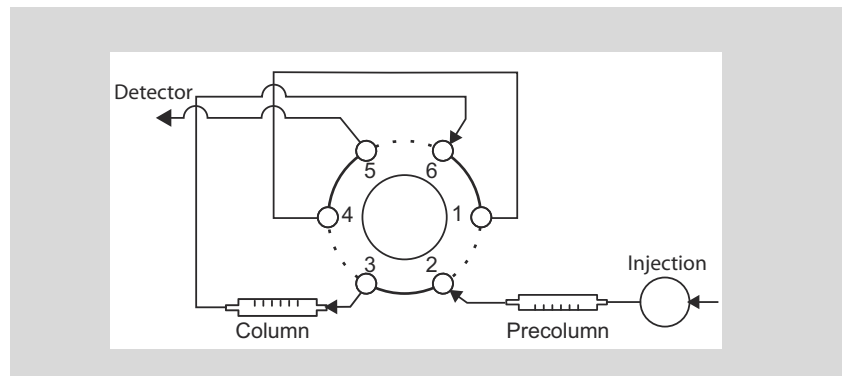

Fig. 15 Precleaning of a sample – Switching over to main column

After switching over the valve on the channel 2–3, the sample is flushed with a second solvent in the main column.

Precleaning of a sample

Basics The precleaning of a sample is used in chromatography, for example in the following cases:

- Preseparation or separation of heavily retarding substances
- Precleaning samples, alternating and time-delayed on different precolumns
- Optimization of analysis times

Injection on precolumn

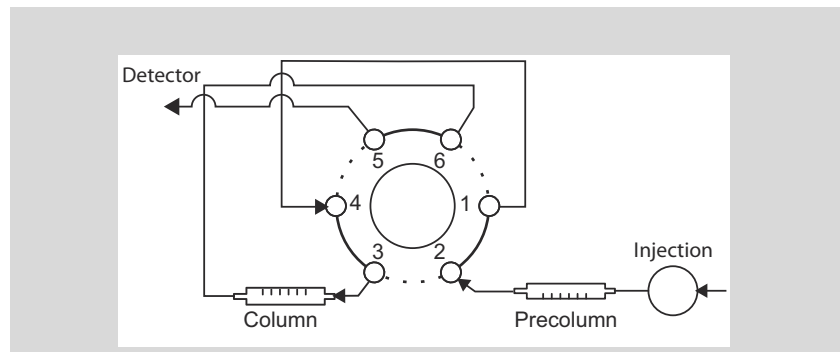

Fig. 16 Application example right: Precleaning alternating on two precolumns and analyze all substances from both precolumns.

The sample is precleaned on precolumn 1 and the weak retarding substances are flushed directly on the analytical column and separated there.

After switching over the valves, precolumn 1 is cleaned and the sample is precleaned on precolumn 2 and flushed to the analytical column to be separated there.

Note: Make sure there is no pressure when switching between the columns so that the columns are not damaged.

Alternating precleaning of a sample

Basics The precleaning of a sample is used in chromatography, for example in the following cases:

- Preseparation or separation of heavily retarding substances
- Precleaning samples, alternating and time-delayed on different precolumns
- Optimization of analysis times

Note: Several valves can be connected with each other to preclean sample alternating on different precolumns for the analysis.

Injection on precolumn

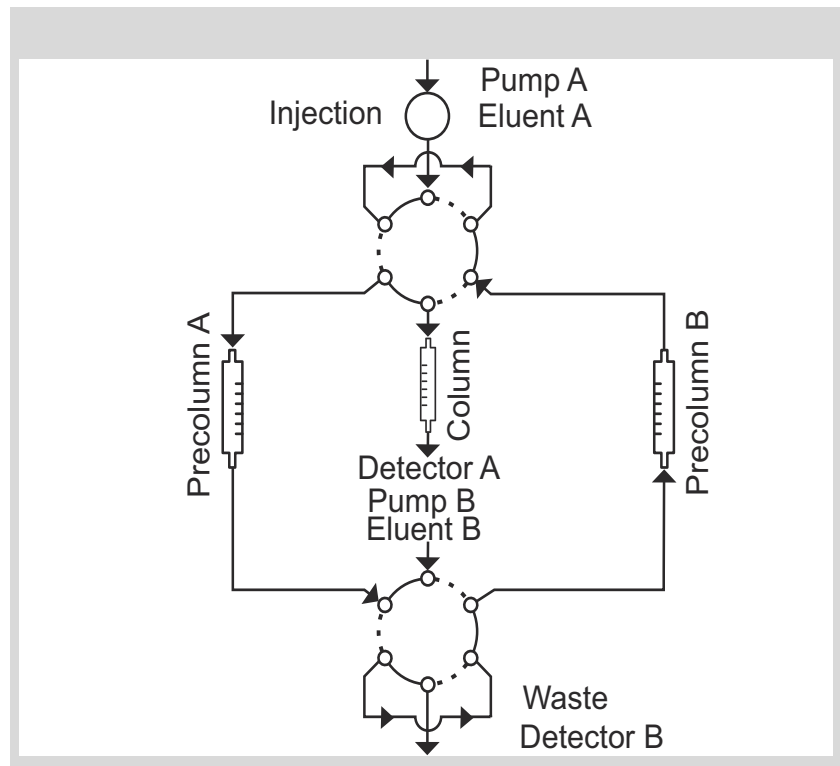

Fig. 17 Alternating sample precleaning – sample is filled in the precolumn B

Precolumn B is filled with sample by pump A and flushed directly to the analytical column. Simultaneously, precolumn B is prepared by pump B with a second solvent. The solvent is fed through detector B to the waste container.

Note: Make sure there is no pressure when switching between the columns so that the columns are not damaged.

Switchover of the direction of flow

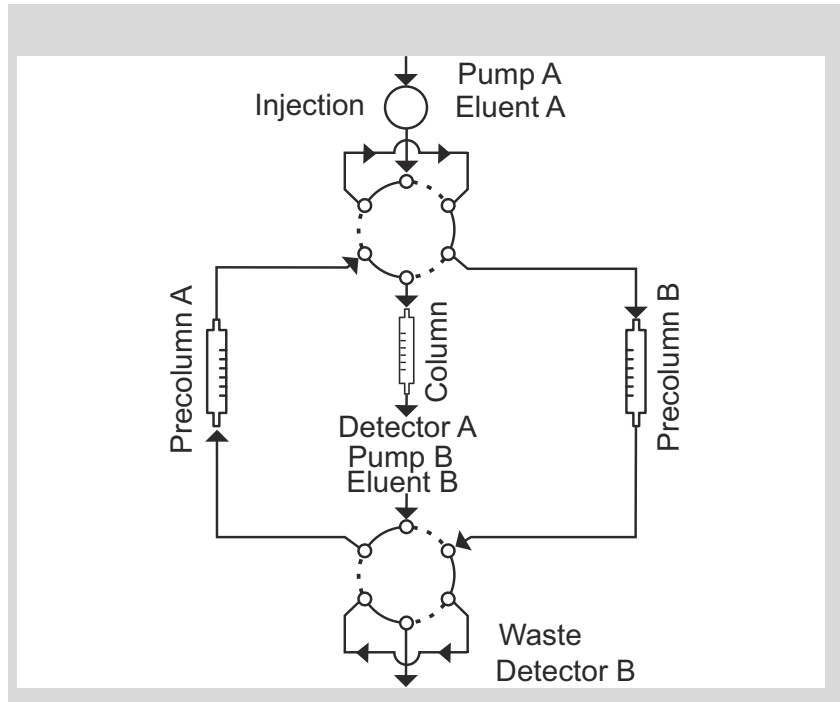

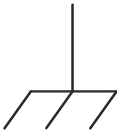
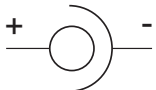





Fig. 18 Alternating sample precleaning – precolumn B is purged and precolumn A is filled with sample

After switching over the valve, precolumn B is cleaned in opposite direction for the next analysis. The sample from precolumn A is flushed in opposite direction with the first solvent into the analytical column.

Symbols and labels

Explanations of symbols and labels on the device or system

Symbol	Explanation
	Hazard symbol indicating microelectronic devices that can be damaged by electrostatic discharge when touched.
<	Setting of descending values
>	Setting of increasing values
I	Injection (I = 'Inject') of a sample on the chromatography column
L	Filling for example a sample loop with sample (L = 'Load')
	Ground connection for grounding the device
24V= 1.5A 	Connection to the power supply with direct current 24 V and 1.5 A
	CE (Conformité Européenne) mark for equipment that complies with the pertinent EU directives and comes with a declaration of conformity from the manufacturer.
	Marking for devices that comply with the canadian requirements for laboratory equipment: CAN/CSA-C22.2 No. 61010-1, second edition, including Amendment 1, or a later version.

Symbol	Explanation
	For your own safety, be sure to read the manual and always observe the warnings and safety information on the device and in the manual!

Safety

Laboratory regulations

Adherence to laboratory regulations

- ▶ Observe national and international regulations pertaining to laboratory work!
 - Good Laboratory Practice (GLP) of the American Food & Drug Administration
 - For development of methods and validation of devices: Protocol for the Adoption of Analytical Methods in the Clinical Chemistry Laboratory, American Journal of Medical Technology, 44, 1, pages 30–37 (1978)
 - Accident prevention regulations published by the accident insurance companies for laboratory work

Solvents

Flammability

Organic solvents are highly flammable. Since capillaries can detach from their screw fittings and allow solvent to escape, it is prohibited to have any open flames near the analytical system!

Leaks and clogged capillaries

- ▶ Regularly check for leaks and clogged capillaries – test back pressure without column!

Suitable Solvents

Solvents suitable for use in HPLC:

- Acetone
- Acetonitrile
- Benzene
- Chloroform
- Acetic acid (10–50%), at 25 °C
- Ethyl acetate
- Ethanol
- Hexane/heptane
- Isopropanol
- Methanol
- Phosphoric acid
- Toluol
- Water

Note: Even small quantities of other substances, such as additives, modifiers, or salts can influence the durability of the materials. The list of selected solvents was compiled based on research in the pertinent literature and is only a recommendation by the manufacturer. If there is any doubt, contact the technical customer service department of the manufacturer.

Unsuitable Solvents	The following solvents can attack the components of the device and are therefore not suitable: <ul style="list-style-type: none"> ▪ Mineral and organic acids (except in buffer solutions) ▪ Bases (except in buffer solutions) ▪ Liquids containing particles
Only suitable to a limited extent	The following solvents are suitable to only a limited extent for use in valves: <ul style="list-style-type: none"> ▪ Methylene chloride ▪ Tetrahydrofuran (THF) ▪ Dimethyl sulfoxide (DMSO) ▪ Slightly volatile solvents ▪ Fluorinated hydrocarbons
Solvent tray	To avoid damage from leaks, always place solvent bottles in a solvent tray on the device.
Self-ignition point	Only use solvents that have a self-ignition point higher than 150°C under normal ambient conditions!
Toxicity	Organic solvents are toxic above a certain concentration. Ensure that work areas are always well-ventilated! Wear protective gloves and safety glasses when working on the device!

PEEK connections

- Disposable PEEK fittings
 - One-piece disposable polyetheretherketone fittings (PEEK) for easier mounting of flexible, thin capillaries (outer diameter 0.5 mm)
 - Tightening torque of the PEEK screw: Tightened by hand (approx. 0.5 Nm)

Protective measures

1. Only perform maintenance tasks described in this manual.
2. All other maintenance tasks are to be performed exclusively by the manufacturer or a company authorized by the manufacturer.

Without exception, the following applies to all maintenance tasks that can be performed by the user:

1. Switch off the device and pull the power plug!
2. Never open a device! High voltage poses a life-threatening risk!

Power supply and mains connection

The device is intended for operation with direct current of 24 volt and 1.5 amperes. The supplied power supply is to be used to connect the device to the mains.

Target group

To what should the user pay particular attention?

To make your HPLC separations as efficient as possible, pay close attention to the following:

- | | |
|--|--|
| Avoiding additional dead volumes | <ol style="list-style-type: none"> 1. Once they have been used, never re-use capillaries in other areas of the HPLC system. 2. Only use a given PEEK fitting for one specific connection and never re-use it for others. Always install new PEEK fittings on each separate port. |
| Using special columns | <ul style="list-style-type: none"> ▶ When using special columns, follow the manufacturer's instructions on caring for the columns! |
| Checking for clogged capillaries | <ul style="list-style-type: none"> ▶ Regularly check for clogged capillaries – test back pressure without column! |
| Using filtered solvents | <ol style="list-style-type: none"> 1. Use ultra-pure, filtered solvents for HPLC – gradient grade. 2. Filtration of substances under analysis 3. Use of inline filters. |
| The device open may only be opened by the technical service department. | <p>Note: Only allow the technical service department of the manufacturer or a company authorized by the manufacturer to open the devices for maintenance and repair work.</p> |

What expertise should users have to safely operate a HPLC device or system?

- Completed degree as chemical laboratory technician or comparable vocational training
- Fundamental knowledge of liquid chromatography
- Participation in an installation of the system performed by the manufacturer or a company authorized by the manufacturer, or suitable training on the system and chromatography software
- Basic knowledge of Microsoft Windows®
- Knowledge regarding substances that are suitable only to a limited extent for use in liquid chromatography

Installation

Protective film on the screen

During transport, a protective film prevents scratches on the screen of the device.

Removing the protective film

- ▶ Remove the protective film from the display.

Scope of supply

The actual scope of delivery is documented by a separate parts list in the packaging.

Overview

Amount/Unit	Type of the device or component
1	Valve drive
1	Power supply 24 V; max. 55 W
1	Power supply cable
1 Set	Tools
1	RS-232 Connection cable
1	Wago terminal strip
1	Network cable, connection cable LAN (patch cable)
1.5 m	Flat ribbon cable, 10-pin
1	Manual

Accessories

Use original parts and original accessories

- ▶ Only use original parts and accessories made by the manufacturer or a company authorized by the manufacturer.

Checking the scope of delivery

1. Check whether the device and accessories are complete.
2. If a part is missing, inform the technical service department of the manufacturer.

Technical customer services of the manufacturer:

Technical customer services Europe

Languages: German and English
 Available by telephone: 8 am to 5 pm (CET)
 Telephone: +49-(0)30-809727-0
 Fax: +49-(0)30-8015010

E-mail contact: E-mail: info@knauer.net (manufacturer)

Space requirements

- Side clearance to other devices:
 - If there is a device on one side, min. clearance of 5 cm.
 - If there are devices on both sides, min. clearance of 10 cm.

Note: Make sure that the power plug on the rear of the device is always accessible, so that the device can be disconnected from the power supply.

Installation site

Ambient conditions of the installation site

- Air humidity: Below 90% (non-condensing)
- Temperature range: 4–40 °C; 39.2–104 °F
- Sunlight: When setting up the device at the installation location, make sure that it is protected against direct sunlight.

Front view of the device

The display for the indication of the position of the valve is visible on the device's front side; the injection or multiposition valve and the buttons for operating the device.

Device display and buttons

The display indicates the status of the valve in the position indicator.

1. Press the [$>$] button to increase the position or start the filling of the sample loop by pressing the 'LOAD' [L] button.
2. Press the [$<$] button to reduce the position or start the injecting of the sample by pressing the 'INJECT' [I] button.

Note: The device is switched off at the power supply to disconnect it from the power mains.

Legend

- A. Position 'Load' [L] or increase position number
- B. Position 'Inject' [I] or reduce position number
- C. Position indicator
- D. Electrical valve
- E. Adapter plate
- F. Allen screws for assembly

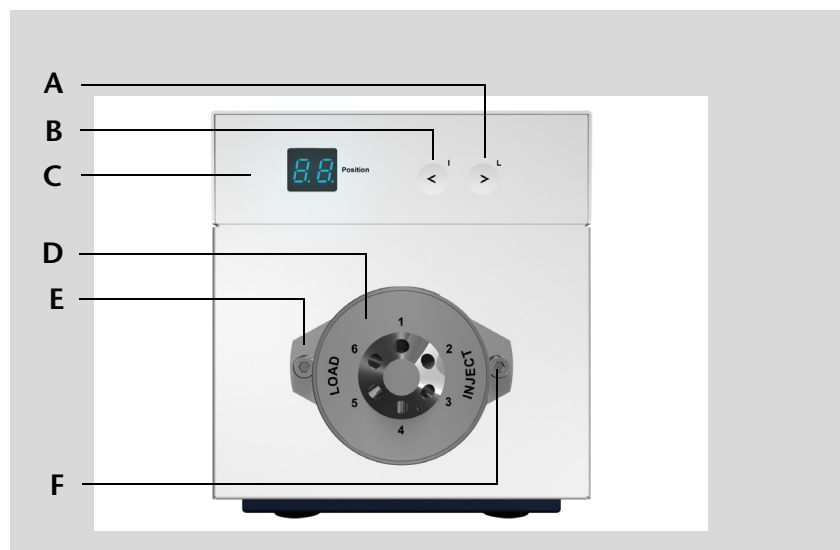

Fig. 19 Device front side of the valve drive with mounted injection valve

Rear view of the device

The rear of the device contains the mains connection socket, ground for grounding the device, connections for external devices, symbols, warning signs and serial number.

Legend

- A. Serial number
- B. CE mark
- C. Warning of the supply voltage
- D. Warning symbol ESD (electrostatic discharge)
- E. Connections RS-232, LAN, *Remote*
- F. Mains power connection
- G. Ground

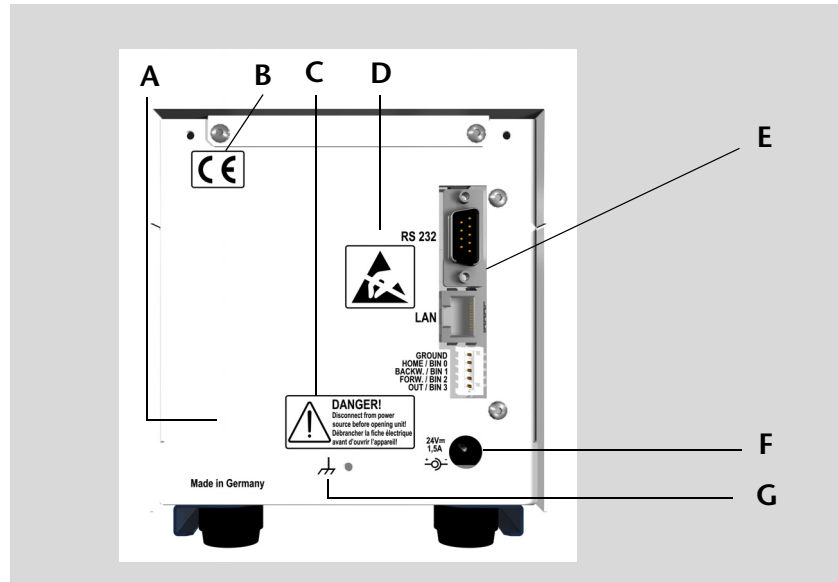

Fig. 20 Rear view of the device, with connections

Manual valves

Manual 6P/3C valve



The rotation of the manual valve is limited to 60°. The reed contact in the injection or multiposition valve gives the start signal for a measurement to the entire analytical system or a detector.

Electrical valves

Electrical valve



The electrically operated 7P/1C valve differ only in the material and some internal dimensions of components. The valve body contains a rotor in its housing. This rotor is preset by disk springs for a certain pressure resistance. The rotation of the electrical valve can be set 360° in a preconfigured raster.

Legend

- A. Axial plate
- B. Axial needle bearing
- C. Compensation plate
- D. Disk spring
- E. Rotor
- F. Rotor seal
- G. Seal ring

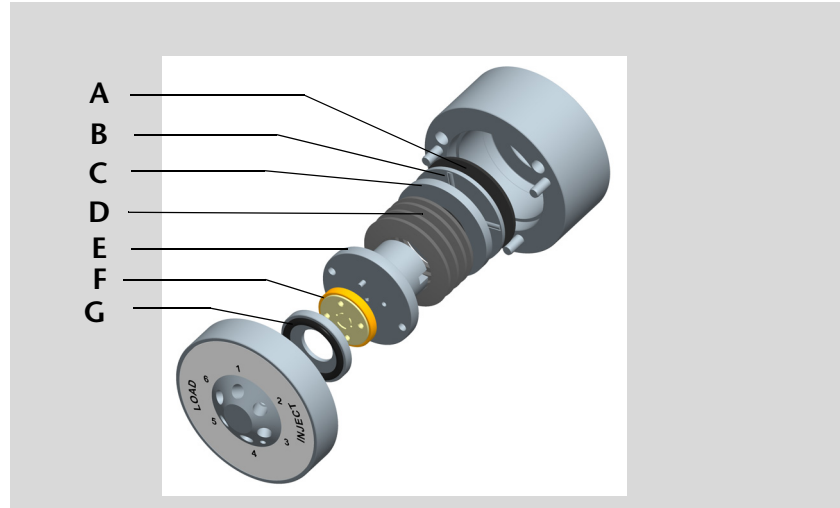

Fig. 21 Exploded view of an electrical valve

Mounting of the valve on the valve drive

Delivery ex works All valve drives are delivered with a ready-mounted injection or multiposition valve. For repeat orders, the electrical valves are delivered with included adapter plate.

Screw the adapter plate to the back side of the valve.

1. Attach the adapter plate the right way around. The openings for the countersunk screws point to the front.
2. Fasten the adapter plate with two Phillips-head screws (M3). Tighten the Phillips-head screw firmly.

Legend

- A. Back side of an electrical valve
- B. Markings for the mounting
- C. Opening for the drive axle of the valve drive
- D. Adapter plate for the mounting
- E. Opening for countersunk screws
- F. Phillips-head screws

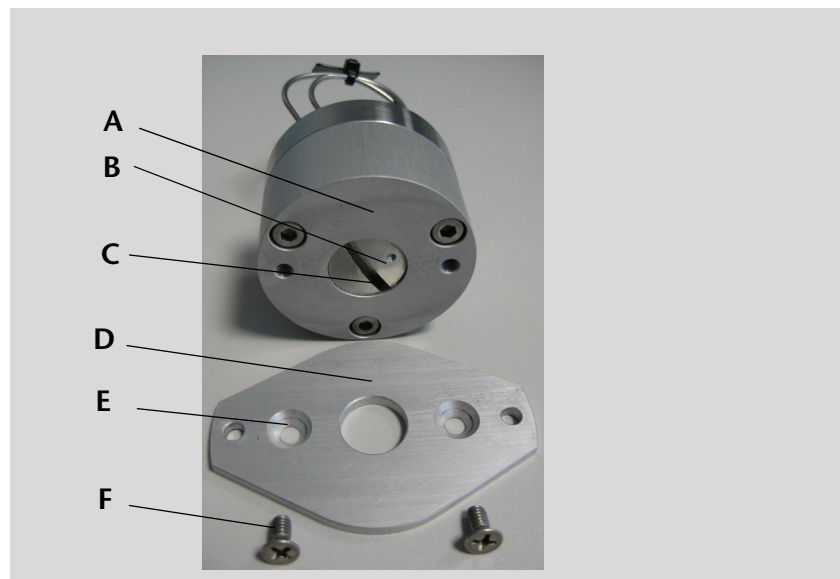

Fig. 22 Back side of the electrical valve – adapter plate for mounting

Screw the valve onto the valve drive

Caution! Risk of mix-up! Always mount the switch or injection valve onto the matching valve drive. An operation of the valve with the wrong valve drive can block the eluent flow. Damage to the device or the system might be the consequence. Observe the operating modes!

Legend

- A. Valve drive
- B. Markings for the true-sided mounting on the drive axle
- C. Injection valve
- D. Position 1 top to the true-sided mounting on the drive axle
- E. Allen screws (M3)
- F. Sample loop, 20 μ l

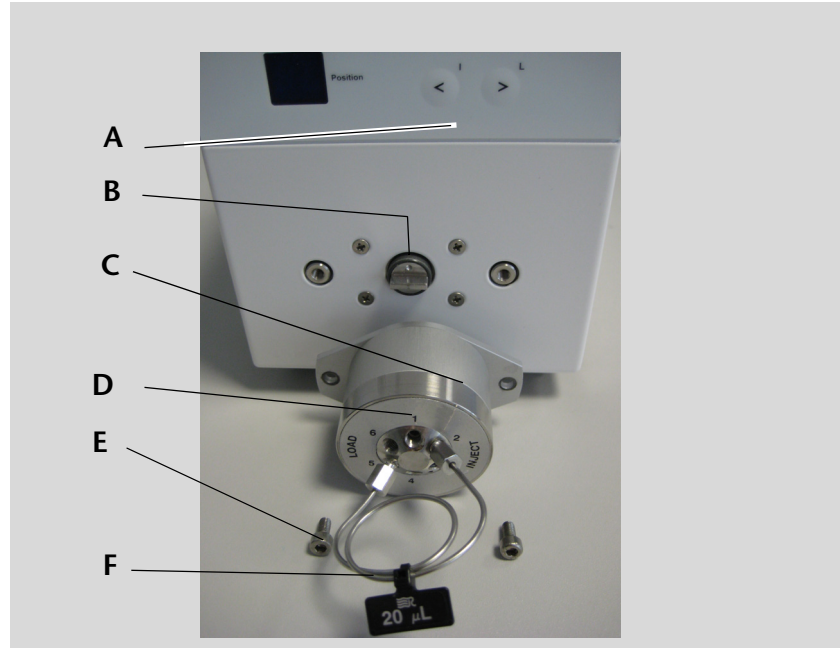

Fig. 23 Mounting of the valve on the valve drive

1. Check the positions of the DIP switches on the bottom of the device to make sure that the electrical control of the valve drive has been set correctly.
2. Switch on the valve drive. The initialization of the valve drive causes the markings on the drive axle to be on top.
3. Port 1 of the injection valve has to point up! Plug the injection valve on the drive axle on the valve drive.
4. Screw the injection valve to the adapter plate with Allen screws M3.

Mounting plate for valves and column holder

Valves can be attached on the side of housings of pumps, detectors, valves, or multifunction modules (assistant) with a mounting plate (order number G6725) and 4 screws.

Legend

- A. Valve drive
- B. Mounting plate
- C. Electrical injection or multiposition valve
- D. Side holder for valves
- E. Column holder

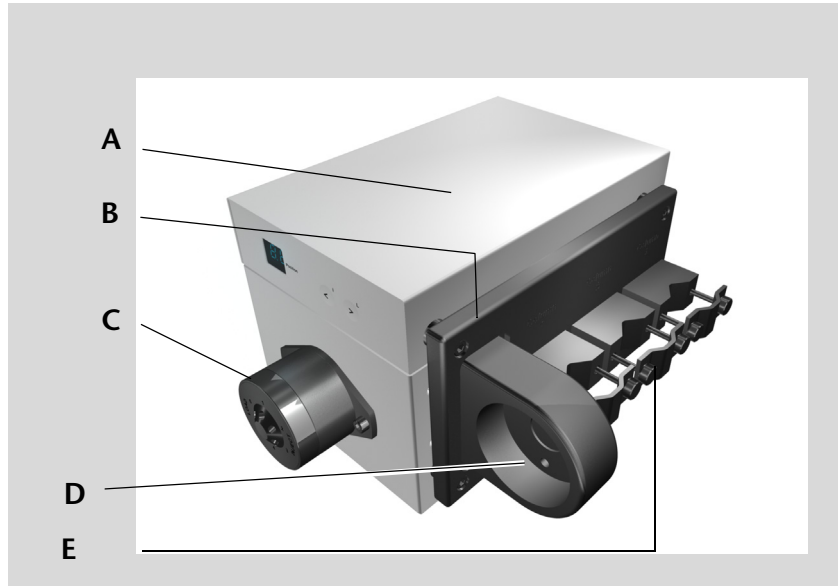

Fig. 24 Mounting plate for valves and column holder

Connecting capillary with valve and seal

Biconical seal or Dynaseal

You can use two seal types to connect the steel or PEEK capillary with the valves – biconical – or *Dynaseal*.

Note: For pressures ≥ 50 bar you should always use a *Dynaseal*.

- A. Biconical seal
- B. Cutting ring
- C. Seal ring

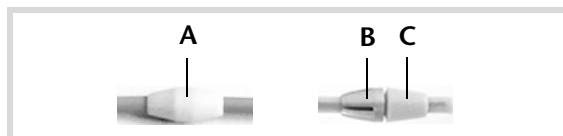
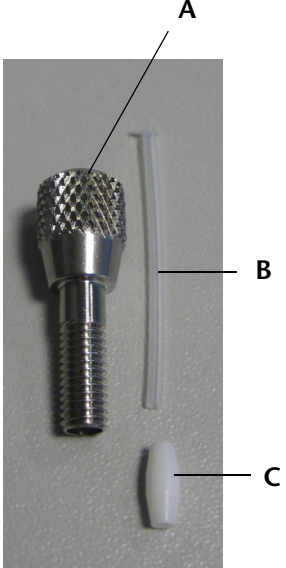

Fig. 25 Biconical seal and Dynaseal

Prerequisite The capillary end was cut off cleanly and at a right angle to the capillary axis with a tube cutter (order number A0569).

Connecting the capillaries

Steps	Figure
<ol style="list-style-type: none"> 1. Place the biconical seal (C) on the needle seal (B). 2. Push the capillary all the way into the valve connection. 3. Screw the screw fitting hand-tight to the seal. 	 <p data-bbox="922 994 1390 1093">Fig. 26 Biconical seal, capillary and screw fitting as example of the syringe connection (A)</p>

UNF seal Steel capillaries are fastened with UNF seals at pressure of over 300 bar. The screw fittings of the seal are retightened with a hexagonal spanner.

Note: All screw fittings are available as a short or long head version. Short-as-possible capillaries with small inner diameters allow for a low dead volume.

Inserting the needle seal in the syringe connection

The needle seal for the syringe connection is available as PTFE or Teflon tube. The sample loop is filled with a syringe or a feed pump. It is necessary for this to insert a needle seal in the syringe connection and to fixate it with a biconical seal.

1. Insert the needle seal in the syringe connection and put a biconical seal on the tip to seal off the needle seal.
2. Screw on the syringe connection with installed needle seal on connection 1 of the valve.

The injection valve is prepared for the injection of sample solutions in the sample loop via a glass syringe with luer lock:

Legend

- A. Injection valve
- B. Syringe connection
- C. Needle seal
- D. Sample loop
- E. Metal cannula with luer lock
- F. Glass syringe

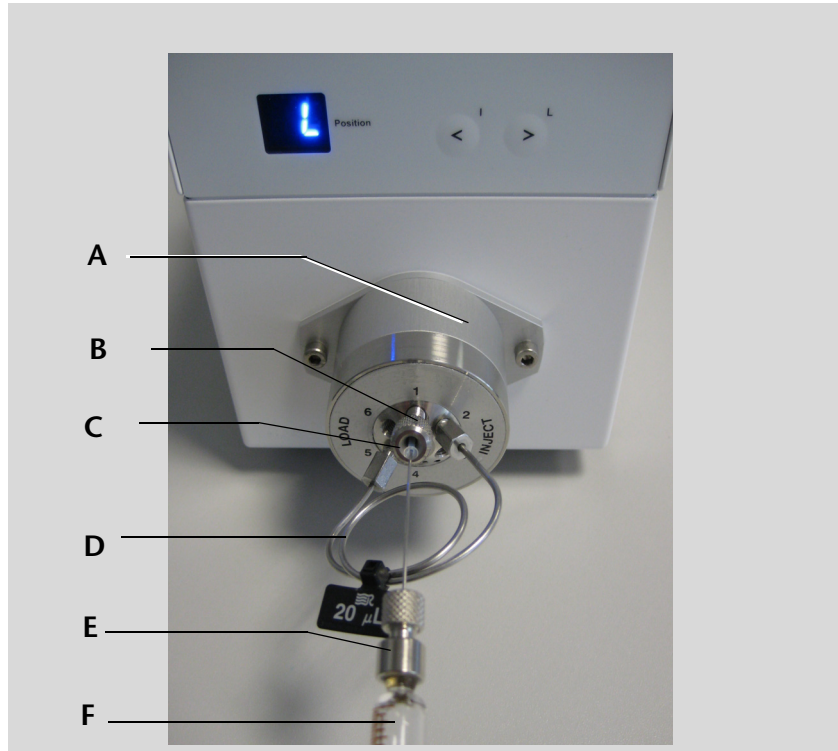

Fig. 27 Injection of a sample with glass syringe and metal cannula

Multifunction module 'Assistant'

The valve can be a component of a multifunction module in which all necessary devices are already permanently assembled in the factory. This multifunction module carries as an order name the product name 'Assistant'.

Note: Explanations on the mechanism and handling of the multifunction module ('Assistant') are described in a separate information sheet and added to the devices.

Legend

- A. Fraction collection valve
- B. Injection valve
- C. Pump

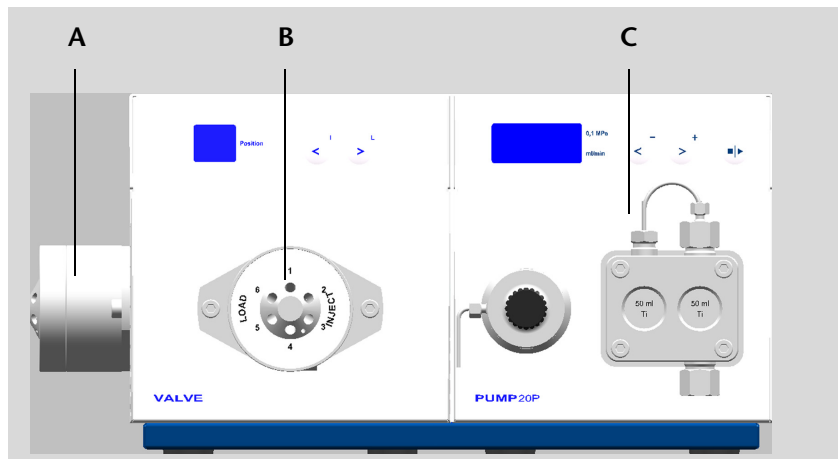

Fig. 28 Example of a multifunction module ('Assistant')

Connection of the pump with other devices

Control of the pump with chromatography software

The valves can be controlled individually or as part of a HPLC system by means of a computer and chromatography software.

Local area network and automatic configuration

The valve is controlled either by means of the function keys on the front of the device or by means of the chromatography software.

Remote control	Normally the valve is controlled by means of the chromatography software via a local network (LAN).
Automatic configuration	A valve connected to a local area network (LAN) is automatically recognized by the chromatography software.
Device status	When used in a local area network (LAN), the system status of the valve can be checked using the chromatography software.
LAN setting	Ex works, the valve is set to DHCP (Dynamic Host Configuration Protocol). This means that the valve is automatically assigned an IP address within the local network.

Interfaces for data transfer

The device uses either a serial interface (A) or a network card (B) for data transfer. The *Remote* terminal strip, connected by a WAGO or a mini-WAGO plug (C), serves to remotely control the device.

- Overview**
- Serial interface RS-232 (USA: EIA 232)
 - Network interface LAN
 - Terminal strip *Remote* for remote control of the device

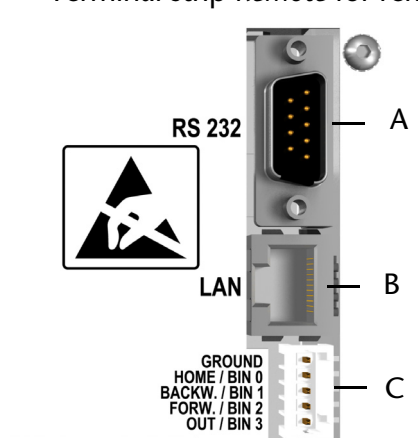

Fig. 29 Terminal strip RS-232, LAN, and remote control

The connections at the interfaces are detected automatically by the device.

The LAN connection and the RS-232 interface can be used for the valves. The remote control is often used when the devices are employed in an analytical system whose chromatography software does not support the driver software of the manufacturer.

- Use the *Remote* terminal strip to connect the valve with external devices.
- Use the LAN connection to connect the valve with external devices within a network.
- Alternatively, connect the valve via the communication interface RS-232 port to a computer.

Caution! Electrostatic discharge can damage the electronics of the valve!
Never touch the electric contacts of the *Remote* terminal strip!

***Remote* terminal strip**

- For receiving start, control and error signals from external devices
- For sending start, control and error signals to external devices



Fig. 30 Terminal strip: *Remote*

GROUND

Start and error signals are started to the ground connection without a current flow.

HOME

If the valve is controlled by *HOME*, it has priority over control via RS-232 or manual operation. As long as the switch-off signal is not cancelled, the valve cannot be started. The indicator of the position flashes to indicate that the start of the valve is prevented by an external signal.

Signal	Explanation
<i>GROUND</i>	Ground connection for start and error signals
<i>HOME/POS. 1</i>	Connection for short circuit for creating a switch signal: <ul style="list-style-type: none"> ▪ Valve drive is set to position 1.
<i>FORWARD/LOADING</i>	Connection for short circuit for creating a switch signal, example for output: <ul style="list-style-type: none"> ▪ LOADING ▪ Set the position of the valve to the next higher one, e.g. from position 2 to position 3
<i>BACKWARD/INJECTING</i>	Connection for short circuit for creating a switch signal, example for output: <ul style="list-style-type: none"> ▪ INJECTING ▪ Set the position of the valve to the next lower one, e.g. from position 6 to position 5
<i>OUT</i>	Connection for short circuit (no current) <ul style="list-style-type: none"> ▪ INJECTING, position 1, low-impedance ▪ LOADING, position 2–6 or 2–16, high-impedance

BIN 0–3

If the DIP switches were set to binary operation, then the connections BIN 0–BIN 2 are available as inputs. The output BIN 3 is active in the valve positions 1–6.

On the 13P/1C and 17P/1C valves, BIN 3 is defined as an input so that the positions 9–12 or 9–16 can be used.

Note: The binary input is inactive during the change of the valve position. This can be used to control further external devices.

Binary code

Prerequisite: The DIP switch of the device was set for the binary control.

A binary code is entered during binary control so that the valve can be set externally in the correct position (nominal position).

Position	BIN 0 ($2^0=1$)	BIN 1 ($2^1=2$)	BIN 2 ($2^2=4$)	BIN 3 ($2^3=8$)	Result, binary
1	0	0	0	0	0
2	1	0	0	0	1
3	0	1	0	0	2
4	1	1	0	0	3
5	0	0	1	0	4
6	1	0	1	0	5
7	0	1	1	0	6
8	1	1	1	0	7
9	0	0	0	1	8
10	1	0	0	1	9
11	0	1	0	1	10
12	1	1	0	1	11
13	0	0	1	1	12
14	1	0	1	1	13
15	0	1	1	1	14
16	1	1	1	1	15

Operating the valves and valve drives

The device can be operated by means of the chromatography software at the workstation or the keyboard on the device. Operator errors and clogged capillaries can cause high pressure spikes.

Caution! Never start or operate the valve without fluid! The rotor seal inside the valve would be damaged.

Switch-on and self-test

After switching on the device, *18* is displayed briefly on the display and the automatic self-test of the device is started. After all tests have been successfully completed, *1* is displayed.

Display of the valve



Fig. 31 Indication of the injection position on the valve's display

Switching on the valve

1. Connect the valve with the plug from the external power supply.
 2. Wait until the pump has completed the self-test.
- The valve is ready for operation.

Control of the valve with chromatography software

The valve can be used with a computer and a chromatography software. This information is described in the manual for the chromatography software.

Valves and valve drives can also be operated without software:

- Manually by buttons of the membrane keyboard
- Externally and electrically via the LAN, RS-232 interfaces
- Analog via the input of the remote control (WAGO)

Note: If several valve drives are used simultaneously in the HPLC system, then make sure that all valves are operated via uniform interfaces (LAN, RS-232 or remote control)

Operating the valve drive manually

Valve drives can be integrated in an HPLC system that cannot be operated via software. The analog output *OUT* and the position *Injecting* on the valve can be used to send a trigger signal via the valve for the measurement or the start of the method to the HPLC system.

- Prerequisites**
- Preparation of the analog mode via DIP switch on the device bottom (DIP switch 2 is set to OUT position)
 - Connect a cable from the analog output of the valve, for example to a pump.
 - Set the valve drive to the setting *Injecting [I]* so send a trigger signal for example to a pump.
 - The program or the method is ended by switching back into the position *Loading [L]*.

The keyboard for operating the device

Buttons	Function	Explanation
	<ul style="list-style-type: none"> ▪ Setting the values ▪ Selecting the function 	<ul style="list-style-type: none"> ▪ Setting the position of the valve ▪ Setting the loading (L) of a sample ▪ Setting the injection (I) of a sample

Valve with 2 switch positions

This valve is set by the buttons [L] for loading or [I] for injecting.

360° valves

These multiposition valves with 6, 12, or 16 switch positions have an internal relaying, e.g. from position 6 directly further to position 1 or back. These so-called 360° valves can therefore be set by one of the two buttons [>] or [<] in any desired position.

Setting the position of the valve

Changing of the position of the valve can be carried out during running operation. In this case, the change takes effect immediately.

- Set the external position with the chromatography software.
- Set the position manually on the device.

Note: To avoid damage to the rotor seal, never allow the valve to run without liquid.



Fig. 32 Maximum number of injection positions

Set the position manually on the valve.

- ▶ Press one of the two buttons to adjust the value of the current injection position. The [$<$] button reduces the value of the injection position; the [$>$] button increases it.



Practical tip! If several valves are switched in series, then the injection positions are synchronized simultaneously on all valves.

Filling the sample into the sample loop

- Prerequisites**
- The sample loop was mounted between the positions 2 and 5
 - A syringe connection was mounted on the desired connection.
 - There are no air bubbles in the injection syringe.

Caution! Damages to the valve due to pointed injection syringes! Use only injection syringes with luer lock and flat-ground cannula.

- ▶ Set the valve to L (= load) to be able to fill the sample loop.

Loading An L for loading is displayed in the *display* (A).

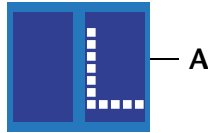

Fig. 33 *Display, load sample*

Legend

- A. Flat-ground 1/16" cannula
- B. Luer lock
- C. Injection syringe

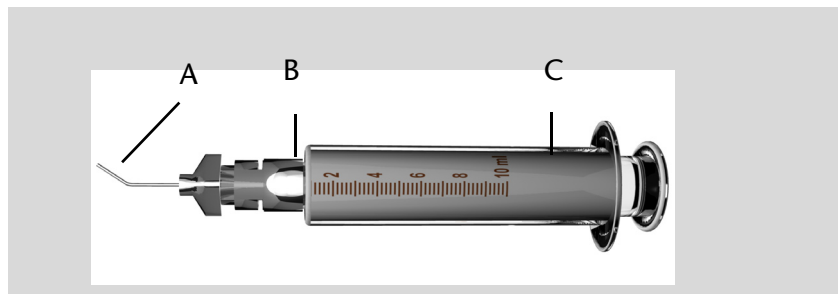

Fig. 34 **Injection syringe with luer lock and flat-ground cannula 1/16"**

- ▶ Insert the injection syringe all the way and empty it to fill the sample loop with sample.

Leave the injection syringe in the syringe connection after the filling.

Injecting the sample

Prerequisites

- The data acquisition was started.
- 1. Set the valve to I (= inject). The sample is injected and measured.

In the *Display*, an I is displayed for injecting (A).



Fig. 35 *Display, inject sample*

- 2. Set the valve back to L (load) and remove the injection syringe.

Operating the valve drive externally

Valve drives can be controlled by electrical signals or even send signals to other devices in the HPLC system. Communication is possible via the following interfaces:

- LAN
- RS-232
- Remote control (WAGO)

Control via one of these interfaces is executed by a terminal program of a software. The electrical valve drives can be controlled analog as well as binary.

Analog control

The technical conditions for the analog and binary control of the valve drives via the interfaces and a terminal program are described in the following.

Note: Each entry of a program line by the terminal program is concluded by [Enter], so that they can be processed.

Settings of the RS-232 interface

9600 baud	8 bit	1 start bit	1 stop bit
-----------	-------	-------------	------------

Command lines for terminal program

Command	Action	Comment
1, 2, 3, ... 6	Valve sets the entered position	Only 360° valves
1, 2, ... 15, 16, 01, ...	Valve sets the entered position	Only 360° valves
H, h	Valve sets the position 1	Only 360° valves; H = home position
L, l	Valve sets the position <i>Loading</i>	Only injection valves
I, i	Valve sets the position <i>Injecting</i>	Only injection valves
V, v	Display version of the program	-
P, p	Display current position of the valve	-
T, t	Display model of the valve (type)	-

Binary control

The specification of nominal positions is required if a valve should be operated without software. A relay is needed, for example, via a device with different interfaces (interface box).

Connecting the flat ribbon cable with the connector strip

To enable signal transmission from external devices to the valve, flat ribbon cables are connected with a connector strip and connected to the *Remote* terminal strip on the device rear of the valve.

Connect flat ribbon cable to the connector strip

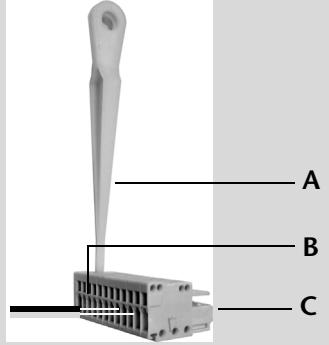
Steps	Figure
<ol style="list-style-type: none"> 1. Place the connector strip (C) on a suitable surface. 2. Put the stylus (A) in the opening on the top of the connector strip and press downward. 3. Keep the stylus pressed down and insert the cable end (B) into the front of the connector strip. 4. Pull out the stylus. 5. Check whether the cables are tightly attached. 	 <p data-bbox="992 734 1385 833">Fig. 36 Connecting the flat ribbon cable with the connector strip</p>

Connect valve drive to the devices *Manager* or *Interface Box*.

In order to send control signals to the valve drive, the *Remote* terminal strip on the device's rear of the valve drive is connected to other devices, for example, a *Manager* or an *Interface Box*.

Principle of the cabling

- Connection of the relay with *ground*
- Connection of the relay with a *binary output*

Legend

- A. Back side of the interface device *Interface Box IF2*
- B. Back side of a valve drive
- C. Terminal strip: *Remote*

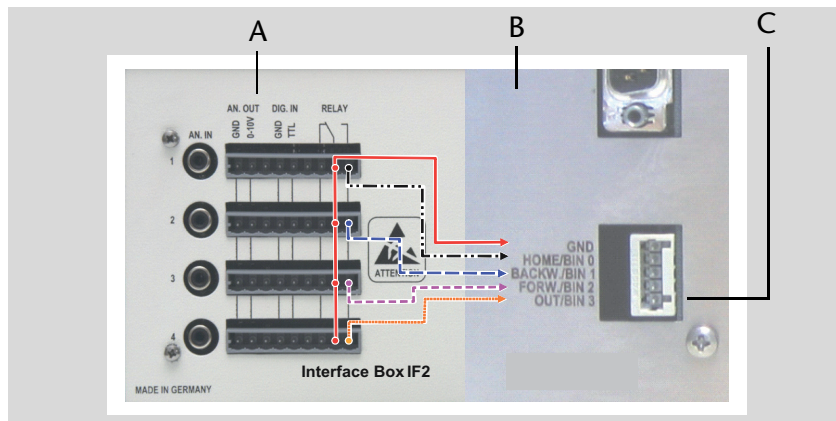

Fig. 37 Terminal strip: *Remote* and *Interface Box IF2*

The integrated circuit of the terminal strip *Remote* is designed as a MINI-WAGO connection in the construction of an open collector.

DIP configuration of the electric valve drive

The DIP switches for configuration of the electric valve drive are set and checked on the device bottom.

- Prerequisite**
- Device is switched off.
 - Switch on the device after the new configuration so that the new configuration becomes effective.

Principles of the setting for the DIP switch on the device

DIP	Function	Comment
1	Specify valve type	-
2	Specify valve position	-
3 and 4	Set the port OUT/BIN 3 on the back of the device as input or output	Set DIP switches 3 and 4 always opposite

Fig. 38 Basic functions of the DIP switches

DIP	I/O	V6	V12	V16
1	IN	360° valve 7P/1C	360° valve 13P/1C	not permitted
	OUT	6P/2C 6P/3C	not permitted	360° valve 17P/1C
2	IN	BIN 0-2 at 360° valves	BIN 0-3	BIN 0-3
	OUT	RS-232, manual, Pos. 1; [I]; [L]	RS-232, manual, Pos. 1; [I]; [L]	RS-232, manual, Pos. 1; [I]; [L]
3	IN	Output OUT/BIN 3	Output OUT/BIN 3	Output OUT/BIN 3
4	OUT			
3	OUT	not permitted	Input OUT/BIN 3	Input OUT/BIN 3
4	IN			

Fig. 39 Details of the setting of the DIP switches among the different series of the valve drives

Drive	Valve	Mode	DIP1	DIP2	DIP3	DIP4
V6	6P/2C	Analog	OUT	OUT	IN	OUT
	6P/3C	Analog	OUT	OUT	IN	OUT
	7P/1C	Analog	IN	OUT	IN	OUT
	7P/1C	Binary	IN	IN	IN	OUT
V12	13P/1C	Analog	IN	OUT	IN	OUT
	13P/1C	Binary	IN	IN	OUT	IN
V16	17P/1C	Analog	OUT	OUT	IN	OUT
	17P/1C	Binary	OUT	IN	OUT	IN

Fig. 40 Combination of valve drive, valve, operating mode, and setting of the DIP switches.

Maintenance and care

Removing the valve

Caution! During assembly, make sure the rotor seal is in the right position and installed properly, because otherwise there may be a mix-up of the channels or clogging may occur.

Note: During disassembly, make sure to mark the position of the rotor seal on the cylinder pins to make the assembly of the valve easier.

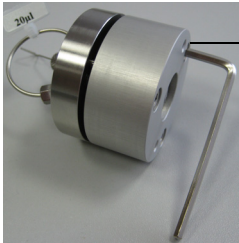
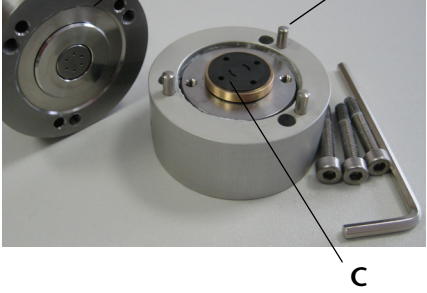
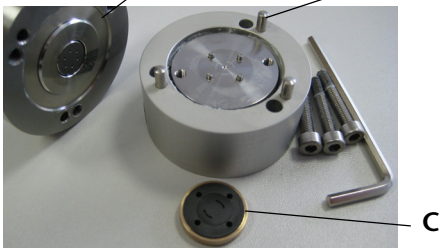
Steps	Figure
<p>1. Alternating, loosen the three Allen screws (A) of the valve with a screwdriver (M3). Hold the housing of valve together when the Allen screws are removed so that the individual parts do not fall out.</p>	 <p>Fig. 41 Open the valve housing.</p>
<p>2. Take off the top part (A). The cylinder pins (B), the inner components and the rotor seal (C) become visible.</p>	 <p>Fig. 42 Remove the top part of the valve</p>
<p>3. Remove the rotor seal (C) and deposit true sided. Mark the position and the installation position of the rotor seal.</p>	 <p>Fig. 43 Deposit the rotor seal true sided with the marking of the position.</p>

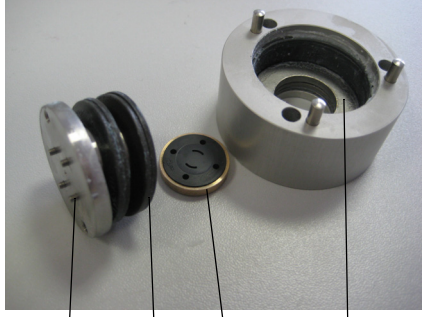
Steps	Figure
<p>4. Hold the inner components of the valve and turn over the bottom part in order to deposit the inner parts orderly. Rotor plate with micro cylinder pins (A), four disk springs in two groups of two (B), rotor seal (C), several sealing disks (D) inside the valve</p>	 <p data-bbox="922 701 1358 761">Fig. 44 Inner components of the valve</p>

Note: Pay attention to the alignment of the rotor seal in the valve during reassembly.

Alignment of the rotor seal in the valve

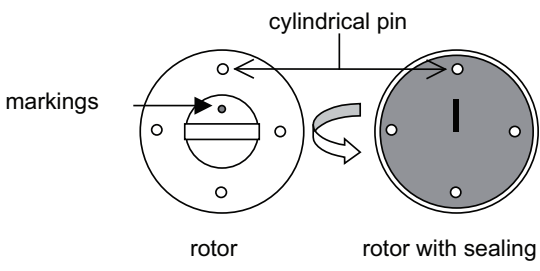
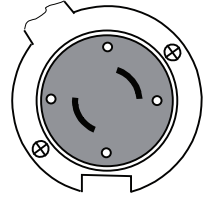
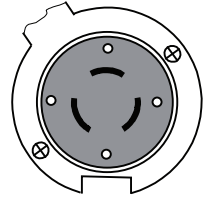
Valve type	Position of the rotor seal during installation
1-channel	 <p>The diagram illustrates the alignment of the rotor seal for a 1-channel valve. It shows two circular views of the rotor. The left view, labeled "rotor", shows a rotor with a horizontal channel and a central dot. The right view, labeled "rotor with sealing", shows the rotor with a vertical line representing the seal. A "cylindrical pin" is shown between the two views, with arrows indicating its position relative to the rotor. "markings" are also indicated on the rotor.</p>
2-channel	 <p>The diagram shows the rotor seal for a 2-channel valve. The rotor is shown with two curved channels and a central dot.</p>
3-channel	 <p>The diagram shows the rotor seal for a 3-channel valve. The rotor is shown with three curved channels and a central dot.</p>

Insert new needle seal.

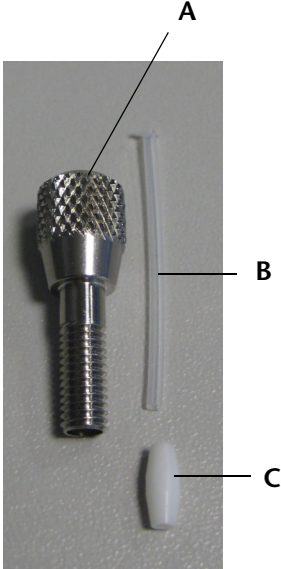
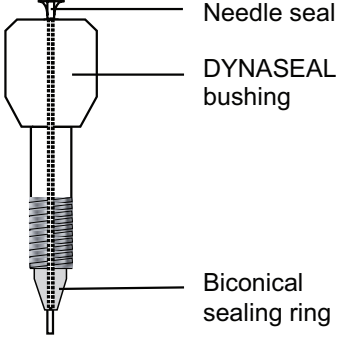
Steps	Figure
<ol style="list-style-type: none"> 1. Removing the old needle seal 2. Insert the new needle seal (B) into the screw fitting (A). 3. Place the biconical seal (C) on the new needle seal and turn everything into the syringe connection at the valve. 4. Screw the screw fitting (A) on the valve moderately tight. 5. Insert the injection syringe all the way into the new needle seal (C). Loosen the screw fitting until the injection syringe can still be pulled easily but with noticeable friction, straight out. 	 <p data-bbox="922 943 1374 1039">Fig. 45 Biconical seal, needle seal, and screw fitting of the syringe connection</p>  <p data-bbox="922 1464 1350 1529">Fig. 46 Schematic display of the syringe connection</p>

Increasing the pressure stability of valves

By changing the disk springs inside the valve, the column switchings can be built up with greater pressure stability.

Valve	Order number	Maximum pressure
13P/1C	A1378	25 bar
17P/1C	A1379	50 bar
17P/1C with 1/16"	A1379-1	100 bar

Cleaning and caring for the device

Note: Risk of damage to the device if cleaning solution enters the device's interior! Only lightly moisten the cleaning cloth!

All smooth surfaces of the device can be cleaned with a mild, commercially available cleaning solution, or with isopropanol.

Environmental protection

Disposal

Drop the devices off at the local municipal waste facilities or send the devices back to the manufacturer where it will be disposed of properly.

Decontamination

Contamination of devices with toxic, infectious or radio-active substances poses a hazard for all persons during operation, repair, sale and disposal of a device.



DANGER! Danger caused by toxic, infectious, or radio-active substances! A contaminated device must never be submitted for repairs, sold, or disposed of!
Contract a specialist company to decontaminate the device or perform the decontamination yourself if you have the required expertise!

All contaminated devices must be properly decontaminated by a specialist company or the operating company before they can be recommissioned, repaired, sold, or disposed of.

All materials or fluids used for decontamination must be collected separately and disposed of properly.

Storage

Ambient storage conditions for the device

Temperature range: 4–40 °C; 39.2–104 °F

Air humidity: Below 90% humidity (non-condensing)

Troubleshooting

The display shows the status of the error:

Display	Cause of the fault	Solution
E0	Setting the position of the valve was not changed	Replacing the rotor seals of the valve
E1	The value of the motor current is too high	Replacing the rotor seals of the valve
E2	The change from one valve position to the next take too long	Replacing the rotor seals of the valve
E3	Switch position of DIP 3 and 4 are not correct	Correct DIP switch 3 and 4
E4	Valve position 1 is not recognized	Replacing the rotor seals of the valve
E5	Switch position of DIP 1 and 2 are not correct	Correct DIP switch 1 and 2
	Binary code is not correct	Correct the binary code.
E6	Memory error	Switch the device off and on again
?	Invalid entry	Correct the entry

Note: If it is not possible to rectify the fault based on this list, then contact the technical support department.

Technical data

Ambient conditions

Temperature range	4–40 °C; 39.2–104 °F
Air humidity	below 90 % humidity (non-condensing)

Valve drive

Control	<ul style="list-style-type: none"> ▪ LAN ▪ RS-232 ▪ Terminal strip: <i>Remote</i> ▪ Buttons on the device ▪ HPLC software EZChrom Elite as of version 3.3.2 plus driver of the manufacturer ▪ Update firmware by the technical support department of the manufacturer
Mains connection	<ul style="list-style-type: none"> ▪ 24 V, 1.5 A ▪ External power supply and power cable 100 -240 V; 50-60 Hz ▪ Integrated power supply (on the multifunction module)
IP protection class	IP-20
Weight	<ul style="list-style-type: none"> ▪ 1.86 kg ▪ approx. 5.3 kg multifunction module with pump and valve drive
Dimensions (length x width x height)	<ul style="list-style-type: none"> ▪ 188 x 122 x 140 mm (without valve)

Valve

Electrical valves

Material	<ul style="list-style-type: none"> ▪ Stainless steel; 1/16"; 1/8" ▪ Peek; 1/16"; 1/8"
Screw fitting	<ul style="list-style-type: none"> ▪ UNF 10/32; 1/16" ▪ DYNASEAL; 1/16"; 1/8"
Switch duration of the valve	approx. 300 ms; via reed contact
Seals	<ul style="list-style-type: none"> ▪ Rotor seals made of VESPEL, TEFZEL, POM-H-TF or ETFE
Sample loops	<ul style="list-style-type: none"> ▪ 1/16" made of stainless steel or PEEK <ul style="list-style-type: none"> - Stainless steel: 5, 10, 20, 30, 50, 75, 100, 200, 500, 1000, 2000 µl - PEEK: 10, 20, 50, 200, 500 µl ▪ 1/8" made of stainless steel or PEEK <ul style="list-style-type: none"> - Stainless steel: 1,2, ... 11, 45 ml - PEEK: 1,2, ... 11, 45 ml
Pressure resistance	<ul style="list-style-type: none"> ▪ maximum 300 bar (30 MPa) for stainless steel capillaries ▪ maximum 150 bar (15 MPa) for PEEK capillaries
Weight	<ul style="list-style-type: none"> ▪ 300 g (valve)
Diameter valve	<ul style="list-style-type: none"> ▪ 47.5 mm

Manual valves

Material	<ul style="list-style-type: none"> ▪ Stainless steel ▪ PEEK
Weight	<ul style="list-style-type: none"> ▪ 356 g (6P/3C valve)
Diameter valve	<ul style="list-style-type: none"> ▪ 47.5 mm

Abbreviations and terminology

Here you can find information on the abbreviations and terminology used in this manual on liquid chromatography.

Terminology	Explanations
Backflushing	Backflushing of columns or precolumns to separate heavily retarding substances by changing the flow direction.
ESD	Microelectronic devices can be damaged by electrostatic discharge when touched.
GLP	Good Laboratory Practice – quality assurance for laboratories
Gradient	Time-dependent composition of solvent (mobile phase) on low-pressure or high-pressure side of system
Gradient grade	Quality designation for ultra-pure and filtered solvents in liquid chromatography
Isocratic	Sample mixtures separated by constant composition of solvent
Channel	The connection of two connections on the valve by a special form of rotor seal
Solvents	Mobile phase (eluent) or carrier for liquid chromatography
Luer lock	Standardized connection system between syringes and cannulaes
NP	Normal phase in adsorption chromatography
OQ	Comprehensive functionality test of individual components in an analysis system (operation qualification)
p. a.	Analysis quality for substances (pro analysi)
Port	Connection on the injection or multiposition valve for injecting of sample solutions
Remote	Connection for remote control of a device
Retarding	A retarding substance is a component of a separation that adheres longer to the column material.
RP	Reversed phase in adsorption chromatography

Legal information

Warranty conditions

The factory warranty for the device is valid for 12 months after the date of dispatch. All warranty claims shall expire in the event that any unauthorized changes are made to the device.

During the warranty period, any components with material or design-related defects will be replaced or repaired by the manufacturer free of charge.

This warranty excludes the following:

1. Accidental or willful damage
2. Damage or errors caused by third parties that are not contractually related to the manufacturer at the time the damage occurs
3. Wear parts, fuses, glass parts, columns, light sources, cuvettes and other optical components
4. Damage caused by negligence or improper operation of the device and damage caused by clogged capillaries
5. Packaging and transport damage

In the event of device malfunctions, contact:

Manufacturer

Wissenschaftliche Gerätebau
Dr. Ing. Herbert KNAUER GmbH
Hegauer Weg 38
14163 Berlin, Germany
Telephone: +49-(0)30-809727-0
Fax: +49-(0)30-8015010
info@knauer.net
Internet: www.knauer.net

The packaging of our devices provides the best possible protection against transport damage. However, immediately inspect each delivery for signs of transport damage. If the shipment is incomplete or damaged, inform the manufacturer within three workdays. Also inform the freight carrier about transport damage.

Declaration of conformity

**Manufacturer name
and address** Wissenschaftliche Gerätebau
Dr. Ing. Herbert KNAUER GmbH
Hegauer Weg 38
14163 Berlin, Germany

**Valve drive and valve
in a multifunction
module ('Assistant')**

Device	Order number
V6	C55000.0; C55020.0
V12	C55100.0; C55110.0
V16	C55200.0; C55210.0

complies with the following requirements and product specifications:

- DIN EN 60799 (June 1999) Electrical accessories – Cord sets and interconnection cord sets
- DIN EN 61010-1 (August 2002) Safety requirements for electrical equipment for measurement, control and laboratory use
 - Low voltage directive (2006/95/EC)
- DIN EN 61000-3-2 (March 2010) Electromagnetic compatibility (EMC) Part 3-2
EN 61000-3-2:2006 + A1:2009 + A2:2009
 - EMC standards (2004/108/EC)
- DIN EN 61326-1 (October 2006) Electrical equipment for measurement, control and laboratory use – EMC requirements
 - DIN EN 61326-1 Corrigendum 2 (April 2011)
- Directives for an environmentally sound use of electrical and electronic equipment
 - RoHS directive 2002/95/EC (February 2003) on the restriction of the use of certain hazardous substances in electrical and electronic equipment
 - WEEE directive 2002/96/EC (February 2003) on waste electrical and electronic equipment

Date Berlin, 2011-02-07



Dr. Alexander Bünz (Managing Director)

The mark of conformity has been applied to the rear panel of the device.



Table of Figures

Fig. 1:	Overview valves and valve drives	6
Fig. 2:	Diagram of a multiposition valve 7P/1C	7
Fig. 3:	Injection valves 6P/2C and 6P/3C	7
Fig. 4:	Valve positions loading and injecting	8
Fig. 5:	Column selection – injection from the 6P/3C valve on column A . . .	11
Fig. 6:	Column selection – injection from the 6P/3C valve on column B . . .	11
Fig. 7:	Column selection with a 2-channel valve	12
Fig. 8:	Backflushing – injection from the 6P/3C valve on the column	13
Fig. 9:	Backflushing – switchover of the 6P/3C valve	13
Fig. 10:	Backflushing precolumn – injection from the 6P/3C valve on the precolumn	14
Fig. 11:	Backflushing precolumn – switchover of the 6P/3C valve	14
Fig. 12:	Sample accumulation on precolumn – injection from the 6P/3C valve	15
Fig. 13:	Sample accumulation – analysis of the accumulated sample	15
Fig. 14:	Precleaning of a sample by a precolumn	16
Fig. 15:	Precleaning of a sample – Switching over to main column	16
Fig. 16:	Application example right: Precleaning alternating on two precolumns and analyze all substances from both precolumns.	17
Fig. 17:	Alternating sample precleaning – sample is filled in the precolumn B	18
Fig. 18:	Alternating sample precleaning – precolumn B is purged and precolumn A is filled with sample	19
Fig. 19:	Device front side of the valve drive with mounted injection valve . .	25
Fig. 20:	Rear view of the device, with connections	26
Fig. 21:	Exploded view of an electrical valve	27
Fig. 22:	Back side of the electrical valve – adapter plate for mounting	27
Fig. 23:	Mounting of the valve on the valve drive	28
Fig. 24:	Mounting plate for valves and column holder	29
Fig. 25:	Biconical seal and Dynaseal	29
Fig. 26:	Biconical seal, capillary and screw fitting as example of the syringe connection (A)	30
Fig. 27:	Injection of a sample with glass syringe and metal cannula	31
Fig. 28:	Example of a multifunction module ('Assistant')	31
Fig. 29:	Terminal strip RS-232, LAN, and remote control	32
Fig. 30:	Terminal strip: <i>Remote</i>	33
Fig. 31:	Indication of the injection position on the valve's display	36
Fig. 32:	Maximum number of injection positions	37
Fig. 33:	Display, load sample	38
Fig. 34:	Injection syringe with luer lock and flat-ground cannula 1/16" . . .	38
Fig. 35:	Display, inject sample	39
Fig. 36:	Connecting the flat ribbon cable with the connector strip	41
Fig. 37:	Terminal strip: <i>Remote</i> and <i>Interface Box IF2</i>	41

Fig. 38:	Basic functions of the DIP switches	42
Fig. 39:	Details of the setting of the DIP switches among the different series of the valve drives	42
Fig. 40:	Combination of valve drive, valve, operating mode, and setting of the DIP switches.	43
Fig. 41:	Open the valve housing.	44
Fig. 42:	Remove the top part of the valve	44
Fig. 43:	Deposit the rotor seal true sided with the marking of the position.	44
Fig. 44:	Inner components of the valve	45
Fig. 45:	Biconical seal, needle seal, and screw fitting of the syringe connection	47
Fig. 46:	Schematic display of the syringe connection	47

Index

A

Abbreviations 52
AC system 10
Accessories 24
Accumulation of a sample 15
Adapter plate 27
Ambient conditions 25, 50
ambient conditions 48
Application examples 10
Assistant, see Multifunction module 31

B

Backflushing 13
Backflushing of a column 13
Backflushing of a precolumn 14
Biconical seal 29
Binary code 35
Buttons 25, 37

C

Care 44, 48
Ccolumn holder 29
Chromatography software 32, 36
Cleaning 48
Column selection
 2-channel valve 12
 3-channel valve 11
Command lines 40
Connector strip 40
Contact address 24
Control
 analog 39
 Binary 40
Customer services 24

D

Data transfer
 Interfaces 32
Dead volume 23
Declaration of conformity 54
Decontamination 48
Device
 Front view 25
Device overview 9
Device safety 21
Device, front view 25
Devices
 Back side 26

DIP

 Switch 42
DIP configuration 42
Disconnecting from power supply 25
Disk springs
 Pressure stability 47
Display 25
Disposal 48
Drived, see Valve drives 6
Dynaseal 29

E

Electrical connections 33
Environmental protection 48
Exploded view of an electrical valve 27
Explosion hazard 10

F

Filter 23
Flammability 21
Flashpoint 22
Flat ribbon cable 40

G

Gradient grade, filtered solvents 23
Ground connection 26
grounding the device 26

H

Hotline
 Europe 24

I

Injection valves 6, 7
Installation 24
Installation site 25
Interface Box 41

Interfaces

 Data transfer 32

K

Keyboard of the device 37

L

Laboratory regulations 21
Laboratory use 10
LAN 32
Leaks 21
Legal information 53

Loading a sample
 Injecting a sample 8
Local network 32
Luer lock 38

M

Mains connection 23
Maintenance 44
Manufacturer 53
Markings 20
Mounting plate 29
Mounting the valve 27
Multi-channel valves, see injection valves 7
Multifunction module 31
Multiposition valves 7

N

Needle seal
 Inserting 47
 Inserting in syringe connection 30
Network, local 32

O

Operating modes 9
Original accessories 24
Overview
 Valves and valve drives 6

P

PEEK connection 22
Position indicator 25
Power plug 25
Power supply 23
Precleaning of a sample 17
 Alternating 18
 By a precolumn 16
Protective film 24
Protective measures 22

R

Rear view of the device 26
Remote control of the device 33
Room ventilation 10
Rotor seal
 Aligning 46
RS-232
 Settings 39

S

Safety 21
Sampled
 Backflushing 14

Samples

 Accumulation 15
 Backflushing 13
 Filling in sample loop 38
 Precleaning 16
 Scope of delivery 24
 Seals 29
 Dynaseal 29
 see technical customer services 24
 Selecting a column 11
 Selection of a solvent 6
 Self-ignition temperature 22
 Self-test 36
 Serial number 26
 Series 9
 Solvent
 Suitable to a limited extent 22
 Toxicity 22
 Solvent selection 6
 Solvent tray 22
 Solvents 21
 Suitable 21
 Unsuitable 22
 Space requirements 25
 storage 48
 Sunlight 10
 Switch valves, see injection valves 7
 Switch-on 36
 Symbols 20

T

 Target group 23
 Technical customer services 24
 Technical data 50
 Terminal program 40
 Terminal strip remote 33
 Terminology 52
 Toxicity 22
 Solvent 22
 Troubleshooting 49

U

 Use, intended 6
 User 23

V

 Valve
 Removal 44
 Screw onto valve drive 28
 Valve drive 6

- Valve drives
 - Operating externally **39**
 - Operating manually **36**
 - Operation **36**
- Valve positions
 - Loading and injecting **8**
- Valves **6**
 - Adapter plate **27**
 - Chromatography software **36**
 - Electrical **26**
 - Exploded view **27**
 - Increasing the pressure stability **47**
 - Manual **26**
 - Manual setting **38**
 - Operation **36**
 - Setting the position **37**

W

- Warnings **21**
- Warranty conditions **53**

© Wissenschaftliche Gerätebau
Dr. Ing. Herbert Knauer GmbH
All rights reserved.

The information in this document is subject to change without prior notice.

Translation of the original German edition of this manual.

2011-01-27

Printed in Germany.

www.knauer.net

HPLC · SMB · Osmometry

Wissenschaftliche Gerätebau
Dr. Ing. Herbert Knauer GmbH
Hegauer Weg 38
14163 Berlin, Germany

Phone: +49-(0)30-809727-0
Telefax: +49-(0)30-8015010
E-Mail: info@knauer.net
Internet: www.knauer.net

