

Azura

Detector UVD 2.1L Instructions



Document No. V6831

HPLC



Note: For your own safety, read the instructions and follow the warnings and safety information on the device and in the instructions. Keep the instructions for future reference.



Note: In case you require this instruction in another language, please submit your request including the corresponding document number via e-mail or fax to KNAUER.

Support: Do you have questions about the installation or the operation of your instrument or software?

International Support:

Contact your local KNAUER partner for support:

www.knauer.net/en/Support/Distributors-worldwide

Support in Germany

(Austria & Switzerland on case-to-case basis):

Phone: +49 30 809727-111 (workdays 9-17h CET)

Fax: +49 30 8015010

E-mail: support@knauer.net

Publisher: KNAUER Wissenschaftliche Geräte GmbH

Hegauer Weg 38

14163 Berlin

Germany

Phone: +49 30 809727-0

Fax: +49 30 8015010

Internet: www.knauer.net

E-mail: info@knauer.net

Version information: Document number: V6831

Version number: 4.2

Release date: August 17, 2023

Translation of the original edition

This instruction applies to products with the product number ADA01XA (AZURA® Detector UVD 2.1L) and ADA04XA (AZURA® Detector UVD 2.1L LWL).

The information in this document is subject to change without prior notice. For the latest version of the instructions, visit our website: www.knauer.net/library.



Copyright: This document contains confidential information and may not be reproduced without written consent of KNAUER Wissenschaftliche Geräte GmbH.

© KNAUER Wissenschaftliche Geräte GmbH 2023
All rights reserved.

AZURA® is a registered trademark of
KNAUER Wissenschaftliche Geräte GmbH.

Table of contents

1. General	1
1.1 About these instructions	1
1.2 Signal words	1
1.3 Additional typographical conventions	1
1.4 Legal information	2
1.4.1 Liability limitation	2
1.4.2 Transport damage	2
1.4.3 Warranty conditions	2
1.4.4 Warranty seal	2
1.4.5 Declaration of conformity	2
2. Basic safety instructions	3
2.1 Intended use	3
2.1.1 Operating ranges	3
2.1.2 Foreseeable misuse	3
2.2 User qualification	3
2.3 Operator responsibility	4
2.4 Personal safety equipment	4
2.5 Safety features on the device	4
2.6 Working with solvents	5
2.6.1 General requirements	5
2.6.2 Contamination by health-threatening solvents	5
2.6.3 Avoiding leakage	5
2.7 Specific environments	6
2.7.1 Earthquake-endangered areas	6
2.7.2 Explosive environment	6
2.7.3 Cooling room	6
2.7.4 Wet room	6
2.8 Maintenance, care and repair	6
2.9 Service request form and decontamination report	7
3. Product information	8
3.1 Features	8
3.1.1 Detector	8
3.1.2 Flow cells	8
3.2 Scope of delivery	8
3.3 Views	9
3.4 Meaning of the LEDs	10
3.5 Symbols and signs	11
4. Installation and initial startup	12
4.1 Unpacking	12

4.2	Ambient conditions	12
4.2.1	Operation site	12
4.2.2	Ambient temperature	12
4.2.3	Space requirements	13
4.3	Power supply	13
4.4	Connecting the leak management	14
4.5	Inserting the flow cell	15
4.6	Setting the optical path length of a preparative flow cell	16
4.7	Connecting capillaries	17
4.8	Computer control	18
4.8.1	Setting up a LAN	18
4.8.2	Configuring the LAN settings	18
4.8.3	Connecting devices with LAN	19
4.8.4	Configuring the router	19
4.8.5	Integrating LAN into company network	20
4.8.6	Controlling several systems separately in LAN	20
4.9	Setting IP addresses	21
4.9.1	Mobile Control: Setting a static IP address	21
4.9.2	Mobile Control: Setting a dynamic IP address via device name	22
4.9.3	Mobile Control: Setting a dynamic IP address via device serial number	22
4.9.4	Firmware Wizard: Setting a static IP address	23
4.9.5	Firmware Wizard: Setting a dynamic IP address	24
4.10	Remote control	25
4.10.1	Connector assignment	25
4.10.2	Analog control	27
4.10.3	Integrator connector	27
4.10.4	Connecting the pin header	27
4.11	Switching on	28
5.	Operation	29
5.1	Checklist before operation	29
5.2	Software control	29
5.2.1	Chromatography software	29
5.2.2	Mobile Control	29
5.3	Setting the wavelength	30
5.4	Resetting the device	30
6.	Functionality tests	31
6.1	Installation Qualification (IQ)	31
6.2	Operation Qualification (OQ)	31
7.	Troubleshooting	32
7.1	LAN	32
7.2	Possible problems and solutions	33
7.3	System messages	34

8. Maintenance and care	37
8.1 Maintenance tasks	37
8.1.1 Maintenance contract	37
8.2 Cleaning and caring for the device	38
8.3 Replacing the flow cell.....	38
8.4 Cleaning the flow cell.....	39
8.4.1 Rinsing the flow cell.....	39
8.4.2 Cleaning the lens of an analytical flow cell	40
8.4.3 Cleaning the light guide of a preparative flow cell.....	41
8.5 Replacing the fiber optics	42
9. Transport and storage	43
9.1 Taking the device out of operation	43
9.2 Packing the device	43
9.3 Transporting the device	43
9.4 Storing the device	43
10. Disposal	44
10.1 AVV-Marking Germany	44
10.2 WEEE registration number	44
10.3 Eluents and other operating materials	44
11. Technical data	45
11.1 Detection.....	45
11.2 Communication	45
11.3 General	46
12. Reorders	47
12.1 Devices.....	47
12.2 Accessories and spare parts.....	47
12.3 Fiber optic connectors	47
12.4 Flow cells.....	48
12.4.1 Analytical flow cells	48
12.4.2 Preparative flow cells.....	48
12.4.3 Preparative flow cells - fiber optics	49
12.4.4 Test cells	50
13. Chemical compatibility of wetted materials	51
13.1 General	51
13.2 Plastics.....	51
13.3 Non-metals	53
13.4 Metals.....	54
14. Index	55

1. General

1.1 About these instructions

These operating instructions enable the safe and efficient operation of the device. The user must have carefully read and understood these operating instructions before starting any work.





The basic prerequisite for safe operation is compliance with all safety instructions (see „2 Basic safety instructions“, p. 3). In addition to the safety and warning instructions in these operating instructions, the local accident prevention regulations and the national industrial safety regulations apply.

These operating instructions are an integral part of the device. It must be kept in the immediate vicinity of the device and accessible to the user at all times.

You can download these and other instructions from the KNAUER website: www.knauer.net/library

1.2 Signal words

Possible dangers related to the device are distinguished in personal and material damages.

Symbol	Meaning
	DANGER (red) indicates a highly hazardous situation. If not avoided, it will result in death or serious injury.
	WARNING (orange) indicates a hazardous situation. If not avoided, it could result in death or serious injury.
	CAUTION (yellow) indicates a moderate hazardous situation. If not avoided, it could result in minor or moderate injury.
	NOTICE (blue) is used to address issues which are not related to physical injury.

1.3 Additional typographical conventions

Note: Specific information are prefixed with the word „Note“ and an information icon.



Note: This is an example.

1.4 Legal information

1.4.1 Liability limitation

The manufacturer is not liable for the following issues:

- Non-compliance of these instructions
- Non-observance of necessary safety precautions
- Improper use
- Operation of the device by unqualified personnel (see „2.2 User qualification“, p. 3)
- Use of non-approved spare parts
- Technical changes by the user such as opening the device and unauthorized modifications
- Violations of General Terms and Conditions (GTC)

1.4.2 Transport damage

The packaging of our devices provides the best possible protection against transport damage. However, check the packaging for transport damage. In case you notice any damage, inform the Technical Support and the shipping company within three workdays.

1.4.3 Warranty conditions

For information on warranty please refer to our general terms and conditions on the website: www.knauer.net/terms

1.4.4 Warranty seal

A blue or orange warranty seal is affixed to some devices.

- A blue seal is used by KNAUER's Manufacturing or Customer Support for devices to be sold.
- After repair, service technicians attach an orange seal onto the identical position.

After repair, the service technician affixes an orange seal in the same place. If unauthorised persons tamper with the device or if the seal is damaged, the warranty will lapse.



1.4.5 Declaration of conformity

The declaration of conformity is enclosed as a separate document with the product and can be obtained online:

www.knauer.net/en/Support/Declarations-of-conformity

2. Basic safety instructions

The device has been developed and constructed in such a way that hazards arising from its intended use are largely excluded. Nevertheless, the following safety instructions must be observed in order to exclude residual hazards.

2.1 Intended use

Only use the device for applications that fall within the range of the intended use. Otherwise, the protective and safety equipment of the device could fail.

2.1.1 Operating ranges

The device is intended to be used indoors for chromatographic applications.

2.1.2 Foreseeable misuse

Refrain from the use of the device for the following purposes or conditions:

- Medical purposes. The device is not approved as a medical product.
- Operating outdoors. Otherwise, the manufacturer does not guarantee the functionality and safety of the device.
- Operation in potentially explosive areas without special and additional explosion protection. Contact the KNAUER Customer Support for more information.

2.2 User qualification

The users are qualified to handle the device if all of the following points apply:

- They have at least a basic knowledge of liquid chromatography.
- They have knowledge about the properties of the used solvents and their health risks.
- They are trained for the special tasks and activities in the laboratory and know the relevant standards and regulations.
- Due to their technical training and experience, they can understand and carry out all the work described in the operating instructions on the instrument and recognize and avoid possible dangers independently.
- Their ability to react is not impaired by the consumption of drugs, alcohol or medication.
- They have participated in the installation of an instrument or training by KNAUER or an authorized company.

If users do not meet these qualifications, they must inform their supervisors.

2.3 Operator responsibility

The operator is any person who operates the device himself or leaves it to a third party for use and who bears the legal product responsibility for the protection of the user or third parties during operation.

The obligations of the operator are listed below:

- Know and follow the applicable work safety regulations
- Identify hazards arising from the working conditions at the place of use in a risk assessment.
- Set up operating instructions for the operation of the device.
- Regularly check whether the operating instructions correspond to the current status of the regulations.
- Clearly regulate and specify responsibilities for installation, operation, troubleshooting, maintenance and cleaning and set clear rules
- Ensure that all personnel who work with the device have read and understood these operating instructions
- Train the personnel who work with the device at regular intervals and inform them about the dangers.
- Provide the necessary safety equipment to the employees working with the unit (see section below).

2.4 Personal safety equipment

The protective measures required in the laboratory must be observed and the following protective clothing worn during all work on the device:

- Safety glasses with side protection
- Protective gloves in accordance with the prevailing ambient conditions and used solvents (e.g. heat, cold, protection against chemicals)
- Lab coat
- Personalised protective safety equipment which is specified in the particular laboratory.

2.5 Safety features on the device

- Power switch: Devices of the AZURA® L series may be switched off using the power switch (toggle switch on the back side of housing) at any time, this causes no damage to the device. To switch off devices of the AZURA® S series, remove the plug from the power socket or use the toggle switch of the power supply unit.
- Front cover: Devices of the AZURA® L series have a front cover as a splash protection for the user
- Leak tray: Devices of the AZURA® L series have a leak tray on the front side. The leak tray collects leaking solvents and protects components from potential damage caused by discharging liquid.
- Lamp: For the detectors AZURA DAD 2.1L, DAD 6.1L und MWD 2.1L, the lamp switches off automatically when the cover is opened.

2.6 Working with solvents

2.6.1 General requirements

- The user is trained for handling different solvents.
- Note recommended solvents and concentrations in these instructions in order to avoid personal injury or damage to the device. For example, certain chemicals may cause PEEK capillaries to swell or burst (see „13 Chemical compatibility of wetted materials“, p. 51).
- Note that organic solvents are toxic above a certain concentration. For handling hazardous solvents see the following section.
- Mobile phases and samples may contain volatile or combustible solvents. Avoid the accumulation of these substances. Ensure good ventilation of the installation site. Avoid open flames and sparks. Do not operate the instrument in the presence of flammable gases or vapors.
- Only use solvents which do not self-ignite under given conditions. This applies especially to the use of a thermostat where liquids could get onto hot surfaces in the interior.
- Degas solvents before use and observe their purity.

2.6.2 Contamination by health-threatening solvents

- Contamination with toxic, infectious or radioactive substances poses a hazard for all persons involved during operation, repair, sale, and disposal of a device.
- All contaminated devices must be properly decontaminated by a specialist company or the operating company before they can be recommissioned, repaired, sold, or disposed (see „10 Disposal“, p. 44).

2.6.3 Avoiding leakage

Risk of electrical shock or short circuit if solvents or other liquids leak into the interior of the device. You can avoid a leakage through the following measures:

- Tightness: Visually check the device or system regularly for leaks.
- Solvent tray: The use of a solvent tray prevents liquids get from the bottles into the inside of the device.
- Eluent lines: Install capillaries and hoses in such a way that, in case of a leak, liquids cannot get into the interior of the devices underneath.
- In case of leakage: Switch off the system. Only take the device into operation if the cause of the leak has been resolved (see „8 Maintenance and care“, p. 37).

2.7 Specific environments

2.7.1 Earthquake-endangered areas

In earthquake-endangered areas, do not stack more than 3 devices on top of each other. Otherwise there is risk of injury due to falling devices or loose parts.

2.7.2 Explosive environment

Never use the system in potentially explosive atmospheres without appropriate protective equipment. For more information, contact the KNAUER Customer Support.

2.7.3 Cooling room

You may operate the device in a cooling room. To prevent condensation, note the following instructions:

- Allow the device to acclimatize for min. 3 hours before taking it into operation.
- After taking into operation, the device should stay switched on.
- Avoid temperature fluctuations.

2.7.4 Wet room

The device must not be operated in wet rooms.

2.8 Maintenance, care and repair

- Avoiding electric shock: Before performing any maintenance and service work, disconnect the device from the power supply.
- Tools: Use only tools recommended or prescribed by the manufacturer.
- Spare parts and accessories: Only use original parts and accessories made by KNAUER or a company authorized by KNAUER.
- PEEK fittings: Use PEEK fittings only for a single port or brand-new PEEK fittings in order to avoid dead volume or not exactly fitting connections.
- Column care: Follow KNAUER or other manufacturer's instructions on caring for the columns (see www.knauer.net/columncare)
- Used capillaries: Do not use any used capillaries elsewhere in the system in order to avoid dead volumes, not exactly fitting connections and spreading contamination.
- Safety features: The device may only be opened by the KNAUER Customer Support of KNAUER or any company authorized by KNAUER (see „1.4.1 Liability limitation“, p. 2).
- For more information visit the KNAUER website: www.knauer.net/hplc-troubleshooting

2.9 Service request form and decontamination report

Devices which are shipped without the completed document "Service request form and decontamination report" will not be repaired. If you would like to return a device to KNAUER, make sure to enclose the completed document: www.knauer.net/servicerequest

3. Product information

3.1 Features

3.1.1 Detector

The UV/VIS detector AZURA® UVD 2.1L is a variable single wavelength detector, designed for measuring quickly and precisely in the ultraviolet and visual spectral range.

The detector can be used in analytical and preparative HPLC systems. It is used in laboratories to analyze substance mixtures. In an HPLC system, the device serves to detect substances in liquids and show their concentration.

3.1.2 Flow cells

Various types of flow cells are available to the user. Pay attention to the compatibility of the flow cells.



Note: A test cell is preassembled to the detector. Before the detector can be used for measurements the test cell has to be replaced by a flow cell. The fiber optics version of the detector is delivered without a test cell.

3.2 Scope of delivery

The following items should be included in the scope of delivery:

- AZURA® Detector UVD 2.1L with test cell *
- Power cable
- UVD 2.1L accessory kit
- AZURA® accessory kit
- Transport protection

Applicable documents:

- Instructions (V6831)
- Installation Qualification ("IQ")
- Declaration of Conformity

* Test cell not supplied with fiber optics version

3.3 Views

Legend:

- ① Leak tray
- ② Capillary guides
- ③ Standby switch
- ④ Status LEDs
- ⑤ Flow cell

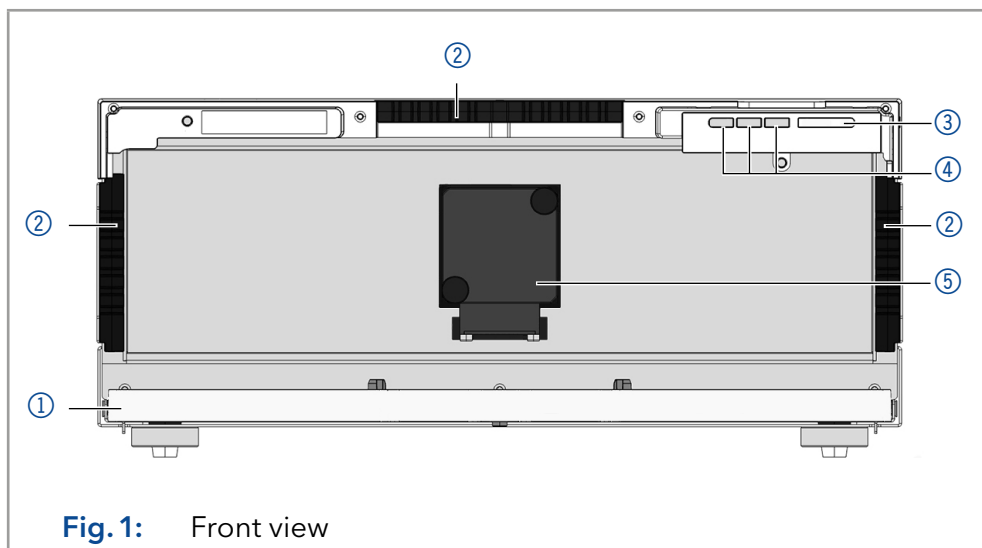

Legend:

- ① Serial number label
- ② Power switch
- ③ Power connection
- ④ Fan
- ⑤ Pin header
- ⑥ RS-232 port (service only)
- ⑦ LAN port
- ⑧ Integrator output

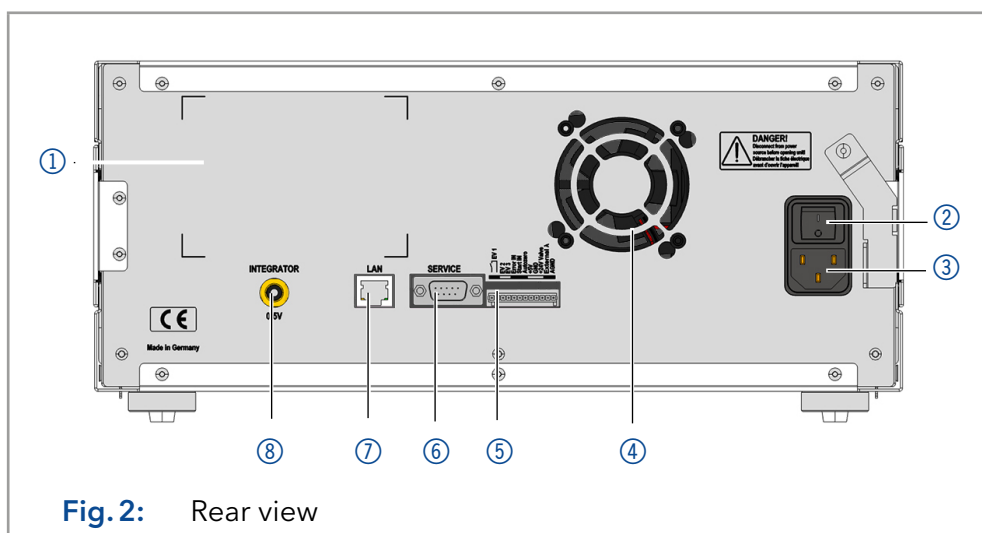

3.4 Meaning of the LEDs

There are three LEDs ① and a standby switch ② on the front of the device. The figure shows the LED panel when the device is switched off.

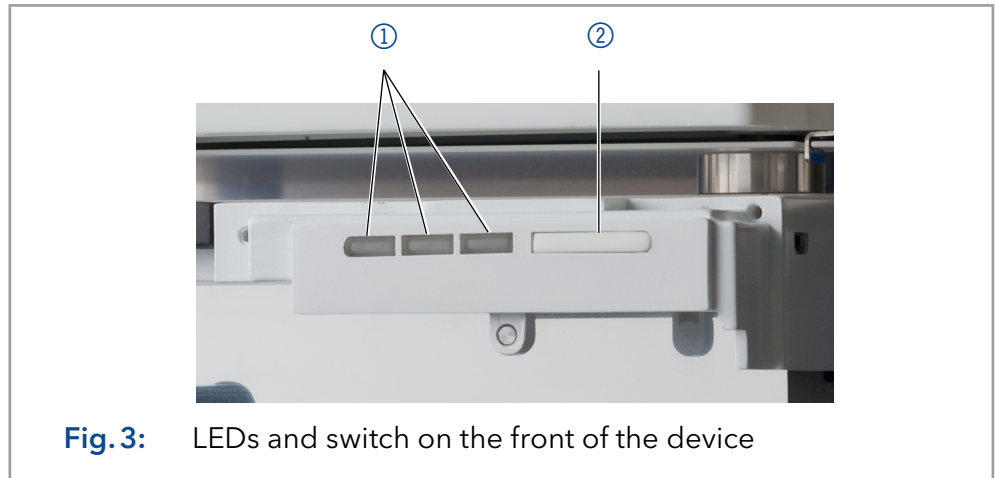

Fig. 3: LEDs and switch on the front of the device

The LEDs show different colors depending on the operating status.

	Color	Operating status	Measures
Left LED	Red	Error message	<ul style="list-style-type: none"> Check the system. Shortly press the switch to deactivate the error message.
	Green	Device is measuring.	-
Center LED	Off	Device is not calibrated or lamp is off.	<ul style="list-style-type: none"> Start calibration via software or via rebooting the device. Switch on the lamp via the software.
	Flashes green	Device is calibrating.	<ul style="list-style-type: none"> Wait until the device is ready.
	Green	Device is ready for operation.	-
Right LED	Green	Device is active.	-
	Blue	Standby	<ul style="list-style-type: none"> Exit standby by pressing the standby switch.







Standby To start the standby, keep the switch pressed for 5 seconds.



Note: Malfunctioning system after repeated standby possible. After repeatedly using the standby, switch off the power switch and back on again, to reset the data storage.

3.5 Symbols and signs

The following symbols and signs can be found on the device:

Symbol	Meaning
	High-voltage hazard
	Electrostatic discharge hazard, damages to system, device, or components can occur.
	Obey maximum load for leak tray during transportation, installation and operation.
	A device marked with CE fulfills the product specific requirements of European directives. This is confirmed in a Declaration of Conformity.
	The device complies with the product-specific requirements of the United Kingdom.
	Testing seals in Canada and the USA at nationally recognized testing centers (NRTL). The certified device or system has successfully passed the quality and security tests.
	A warranty seal is affixed to some devices (see „1.4.4 Warranty seal“, p. 2).

4. Installation and initial startup

Before you determine the operation site, read chapter (see „11 Technical data“, p. 45). There you will find all device-specific information on power supply, ambient conditions and humidity.



Note: The intended use be ensured only if the requirements for ambient conditions of the operating environment are met.

4.1 Unpacking

Process

Procedure

1. Place the packaging in such a way that the lettering on the label is in the correct position.
2. Check the packaging, the device and the accessories for transport damage.
3. Check the scope of delivery. In the event of incomplete delivery, contact Technical Support immediately.
4. When lifting, carrying or moving the device, grab the unit only from below on the sides. Do not hold onto front cover or leak tray, as these parts are loosely attached to the device.

Next steps

- Keep the included packing list for repeat orders.
- Keep the original packaging for safe storage or transportation.

4.2 Ambient conditions

4.2.1 Operation site

Observe the following requirements for the operation site so that the measurement results are not influenced:

- Place on a firm, level and straight surface.
- Protect against direct sunlight.
- Do not expose to air drafts such as air conditioning systems.
- Do not set up the to other machines that cause floor vibrations.
- Keep from high frequency sources.
- Ensure adequate ventilation (see “4.2.3 Space requirements“, p. 13).
- Avoid temperature fluctuations (see “4.2.2 Ambient temperature“, p. 12).

4.2.2 Ambient temperature

If the ambient temperature of the device is abruptly changed (e.g. when it is installed in a cooling chamber), condensation will form inside the device and may cause damage to the device. Allow the device to acclimate for 3 h, before it is connected to the power supply and taken into operation.

4.2.3 Space requirements

- Make sure that the power plug on the power supply (wall socket or power strip) is always accessible, so that the device can be disconnected from the power supply.
- Ensure adequate ventilation around the device, otherwise it may overheat and malfunction:
 - Min. 5 cm distance if another device is set on one side.
 - Min. 10 cm distance if further devices are set on both sides.
 - At least 15 cm to the cooler fan on the rear.
- The mounting of a small device to an AZURA® L device with a mounting bracket does not affect the performance of either device. The space requirements specified in both device instructions do not apply in this case.

4.3 Power supply

Power supply requirements

- Failure-free power supply: For failure-free operation, the electrical voltage must be free of fluctuations, residual currents, voltage peaks and electromagnetic interference. The device must receive sufficient voltage and reserve capacity.
- Check voltage: Only connect devices to a power supply whose voltage corresponds to the permissible voltage of the device.
- Power consumption: The nominal power of the connected devices must not exceed 50 % of the highest connected power capacity, since higher currents can flow briefly when the device is switched on.
- Main connection: The electrical power supply at the operation site must be connected directly to the nearest main power connection.
- Grounding: The connectors for the voltage must be grounded accordingly.

Power supply cables and plugs

- Original parts: For power supply, use the supplied power cable and plug to meet the specifications (see "11 Technical data", p. 45). Detachable power cables are not allowed to be replaced with other cable types.
- Country-specific plugs: Before switching on the device, check whether the supplied plug is approved for your country. Overview of the device- and country-specific plug types from KNAUER: www.knauer.net/plugs
- Power strips: If several devices are connected to one power strip, always consider the maximum power consumption of each device.
- Access to power supply: Make sure that the power plug on the power supply (wall socket or power strip) is always accessible, so that the device can be disconnected easily from the power supply.
- Damaged power supply cables and plugs: For safety reasons, damaged or faulty cables and plugs must not be used to connect the device to the power supply. Replace defective cables and plugs only with KNAUER accessories.

4.4 Connecting the leak management

The leak management consists of the leak sensor and the drainage system. The drainage system ensures that escaping liquids flow into a waste bottle. If there is too much liquid, the red LED starts flashing. Both the device and the data acquisition via chromatography software are stopped.

Prerequisites The front cover is removed.

Procedure

Process

Figure

- Carefully push the funnel ① into the center opening of the capillary guide ②.

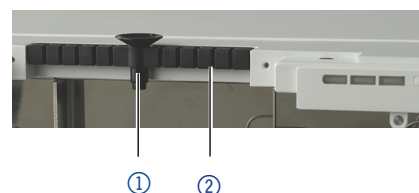

Fig. 4 Funnel and capillary guide

- Push the long ending of the first nozzle ④ into the hose ③.

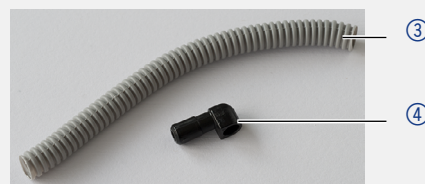

Fig. 5 Hose and nozzle

- Afterwards, push the nozzle onto the funnel.
- Push the other end of the hose onto the nozzle ⑤ of the leak tray.

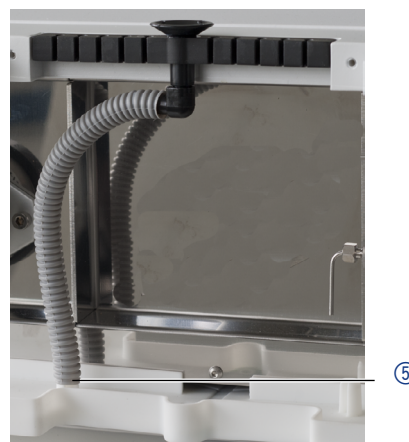

Fig. 6 Hose connected to device

- Attach the waste nozzle ⑥ to the bottom unit
- Attach the wastehose to the waste nozzle and connect it to the waste container.
- Place the waste container below the devices.

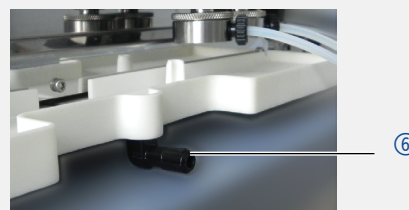

Fig. 7 Leak tray with nozzle

Next step Attach the front cover.

4.5 Inserting the flow cell



Note: The test cell is used during operation qualifications and has to be stored.

- Prerequisite**
- Detector is switched off.
 - Power plug is disconnected from the device.

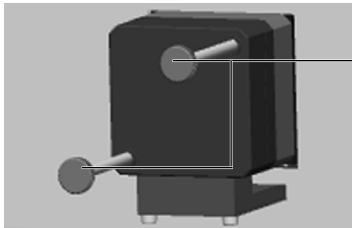
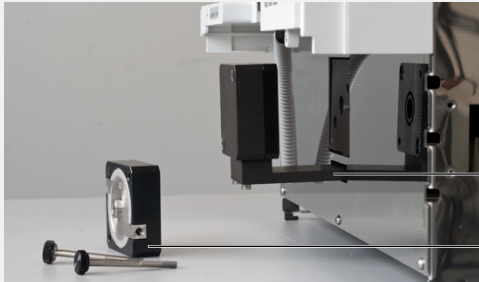
Steps	Figure
<p>Procedure</p> <p>1. Unscrew the 2 knurled-head screws ①.</p> <hr/> <p>2. Pull out the slide ②.</p> <hr/> <p>3. Remove the test cell.</p>	 <p>Fig. 8 Removing the screws</p>
<p>4. Insert the flow cell ③ into the slide.</p> <hr/> <p>5. Push the slide into the detector ②.</p> <hr/> <p>6. Insert the knurled-head screws and screw tight.</p>	 <p>Fig. 9 Assembling the flow cell</p>

Result The flow cell is assembled.

Next step Connect the capillaries.

4.6 Setting the optical path length of a preparative flow cell

Depending on type, the path length is factory set to 2 mm, 3 mm, or 10 mm. For the 2 mm flow cells you can remove the spacers on one or both sides and hence change the path length to 1.25 mm or 0.5 mm.

⚠ WARNING

Eye injury

Eye irritation by UV light. Bundled UV light can escape from the flow cell or fiber optic cables.

→ Switch off the detector and disconnect it from the power supply.

Legend:

- ① Threaded ring
- ② Cover
- ③ Spacer
- ④ Compression bushing
- ⑤ Light guide with seal ring

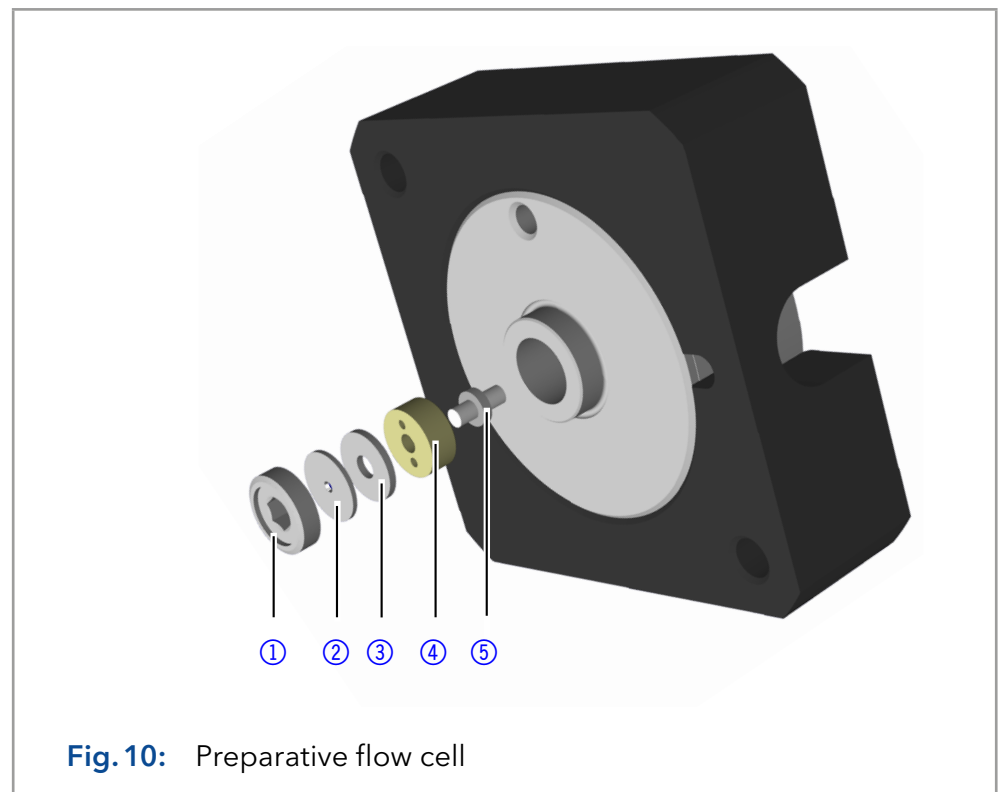

Fig. 10: Preparative flow cell

Prerequisite Flow cell is removed from the detector.

Tools Allen screwdriver, size 3

Process

- Procedure**
1. Using the allen screwdriver, loosen the threaded ring ①.
 2. Remove the cover ②.
 3. To shorten the optical path length, remove the spacer ③.
To enlarge the optical path length, put in one or both spacers.
 4. Insert the cover ②.
 5. Using the allen screwdriver, tighten the threaded ring ① with a torque of 1.1 Nm.

Result The optical path length is set.

Next step Mount the flow cell onto the detector.

4.7 Connecting capillaries

NOTICE

Component defect

Damage to components due to excessive tightening possible.
Observe the torque of the screw connection.

- Use 5 Nm torque for stainless steel fittings.
- Use 1 Nm torque for PEEK fittings.



Note: PEEK fittings withstand a maximum pressure of 400 bar.

Prerequisite Flow cell is removed from the detector.

Tools Torque wrench

	Steps	Figure
Procedure	1. Push the capillary ② through the fitting ①.	
	2. Push the clamping ring ③ onto capillary.	
	3. Manually, screw together the capillary ⑤ and the flow cell ④. Tighten the fitting with the wrench.	
		

Fig. 11 Capillary fitting

Fig. 12 Capillary and flow cell

Result The capillary is connected.

4.8 Computer control

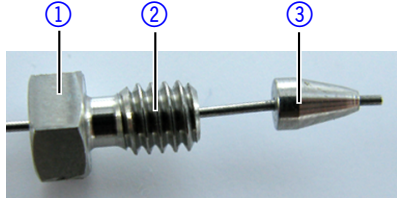
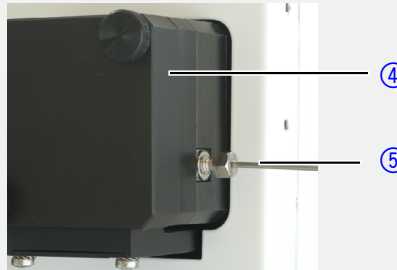

Note: HPLC devices from KNAUER only work with IP addresses, which have been assigned by IPv4. IPv6 is not supported.

This chapter describes how to set up a chromatography system in a local area network (LAN) and how a network administrator can integrate this LAN into your company network. The description applies to the operating system Windows® and all conventional routers.

4.8.1 Setting up a LAN

To set up a LAN, we recommend to use a router. That means the following steps are required:

	Process
Procedure	1. On the computer, go to the control panel and check the LAN properties.
	2. Hook up the router to the devices and the computer.
	3. Set up the router for the computer network.
	4. Install the chromatography software.
	5. Switch on the device and run the chromatography software.

Next step Set the LAN properties (see chapter 4.8.2 on page 18).

4.8.2 Configuring the LAN settings

The LAN uses only one server (which is normally the router) from that the devices automatically receive their IP address.

Prerequisites	<ul style="list-style-type: none"> ■ In Windows, power saving, hibernation, standby, and screen saver must be deactivated. ■ In case you use an USB-to-COM box, the option "Allow the computer to turn off this device to save power" in the device manager must be deactivated for all USB hosts. ■ Applies to all LAN devices: Disable the setting for the network adapter in Device Manager "Allow the computer to turn off this device to save power".
----------------------	---

	Process
Procedure	1. In Windows, open <Network and Sharing Center>.
	2. Double-click on <LAN connection>.
	3. Click on the button <Properties>.
	4. Select <Internet Protocol version 4 (TCP/IPv4)>.
	5. Click on the button <Properties>.
	6. Check the settings in the tab <General>. The correct settings for the DHCP client are: a) Obtain an IP address automatically) Obtain DNS server address automatically
	7. Click on the button <OK>.

Next step Connect devices (see chapter 4.8.3 on page 19).

4.8.3 Connecting devices with LAN

A router ② has several LAN ports ③ and one WAN port ④ that can be used to integrate the LAN into a wide area network (WAN), e.g. a company network or the Internet. In contrast, the LAN ports serve to set up a network from devices ① and a computer ⑤. To avoid interference, we recommend operating the chromatography system separately from the company network.



Note: You will find patch cables for each device and the router in the accessories kit. To connect the router to a LAN, an additional patch cable is required, which is not supplied within the scope of delivery.

Legend:

- ① Devices
- ② Router
- ③ LAN ports
- ④ WAN/Internet connection
- ⑤ Computer

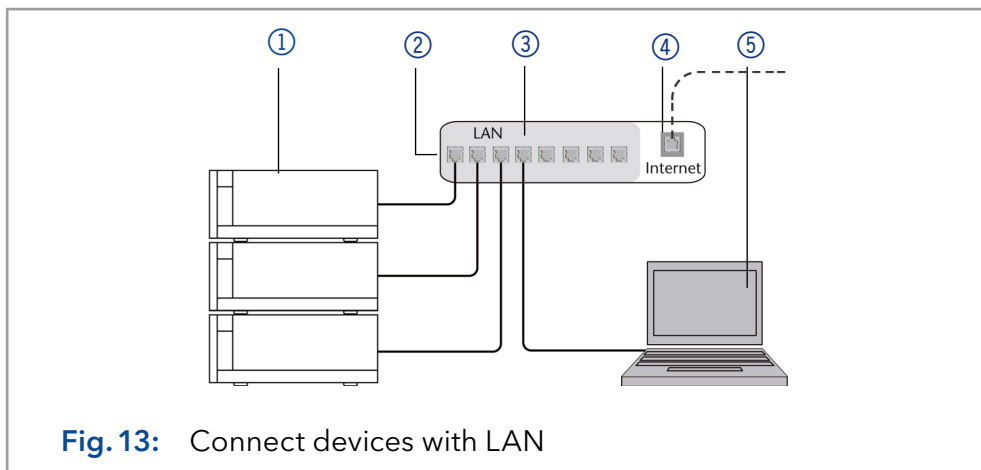

Fig. 13: Connect devices with LAN

- Prerequisites**
- The computer is switched off.
 - There is a patch cable for each device and the computer.

Process

- Procedure**
1. Use the patch cable to connect the router and the computer. Repeat this step to connect all devices.
 2. Use the power supply to connect the router to the mains power system.

Next step Set the router properties (see chapter 4.8.4 on page 19).

4.8.4 Configuring the router

The router is preset at the factory. Information about address, user name and password is noted in the router manual: www.knauer.net/router.

Process

- Procedure**
1. To open the router configuration, start your Internet browser and enter the IP address (not for all routers).
 2. Enter user name and password.
 3. Configure the router as DHCP server.
 4. In the router configuration, check the IP address range and make changes if necessary.



Note: If the IP address range has been changed, it is essential to note this information on the router.

Result Once the router has assigned IP addresses to all devices, the chromatography software can be used to remotely control the system.

4.8.5 Integrating LAN into company network

A network administrator can integrate the LAN into your company network. In this case you use the WAN port of the router.

Prerequisites ■ There is a patch cable for the connection.

Process

- Procedure**
1. Make sure that there is no overlap between the IP addresses of the router and the corporate network.
 2. In case of an overlap, change the IP address range of the router.
 3. Use the patch cable to connect the router WAN port to the company network.
 4. Restart all devices, including the computer.

Result The LAN is now integrated into the company network.

4.8.6 Controlling several systems separately in LAN

Devices connected to a LAN communicate through ports, which are part of the IP address. If more than one chromatography systems are connected to the same LAN and you plan on controlling them separately, you can use different ports to avoid interference. Therefore, the port number for each device must be changed and this same number must be entered into the device configuration of the chromatography software. We recommend to use the same port number for all devices in the same system.



Note: The port is set to 10001 at the factory. You must use the same numbers in the device configuration of the chromatography software as in the device, otherwise the connection fails.

Process

- Procedure**
1. Find out port number and change it on the device.
 2. Enter the port number in the chromatography software.

Result The connection is established.

4.9 Setting IP addresses

Note: Set a static IP address.

Note: Check the IT security standards for your lab before intervening in the LAN settings.

There are two ways for the device to set a fixed (static) or dynamic (DHCP) IP address via software: Mobile Control or Firmware Wizard.

4.9.1 Mobile Control: Setting a static IP address



Note: The device is preset to a dynamic address (DHCP). To ensure a constant LAN connection between the chromatography software and the instrument, we recommend switching the instrument to a static IP address for certain applications. For more information about LAN settings see [Mobile Control/systems solutions](#) on our website.

Prerequisites

- The device is switched on.
- Mobile Control is installed and running.
- The connection between Mobile Control and the device has been established.

Process

Procedure

1. In Mobile Control, click  <Settings>.
2. On the <General> tab, choose the device name.
3. In <Network Settings>, choose the setting <Static> ①.
4. Enter the IP address into the text box <IP Address> ②.
5. If necessary, change the subnet mask and the gateway ③.
6. Click  in the top right corner.
7. Restart the device (recommended).

Legend:

- ① IP address mode
- ② Text box for IP address
- ③ Text field for subnet mask/gateway

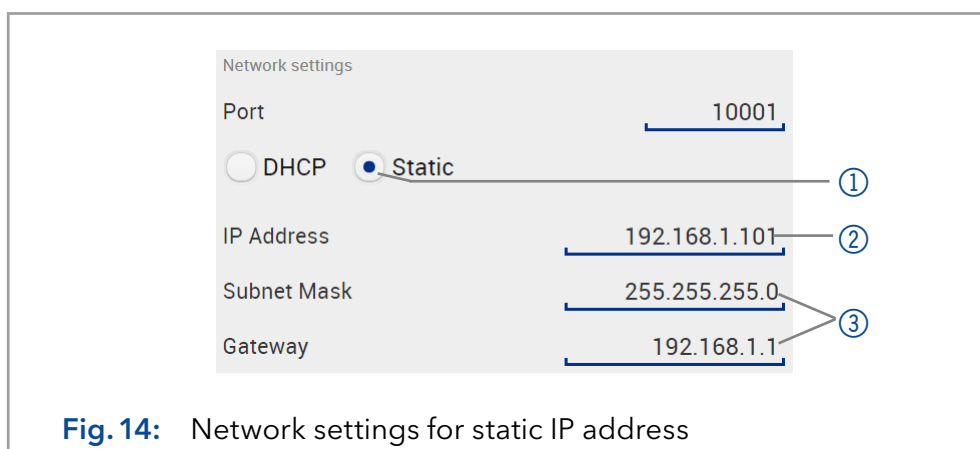





Fig. 14: Network settings for static IP address

Result The device is now accessible via the static IP address.

4.9.2 Mobile Control: Setting a dynamic IP address via device name

- Prerequisites**
- The device is switched on.
 - Mobile Control is installed and running.
 - The connection between Mobile Control and the device has been established.

Process

- Procedure**
1. In Mobile Control, click  <Settings>.
 2. On the <General> tab, choose the device.
 3. In <Network Settings>, choose the setting <DHCP> .
 4. Click  in the top right corner.
 5. Restart the device (recommended).

Legend:

-  IP address mode

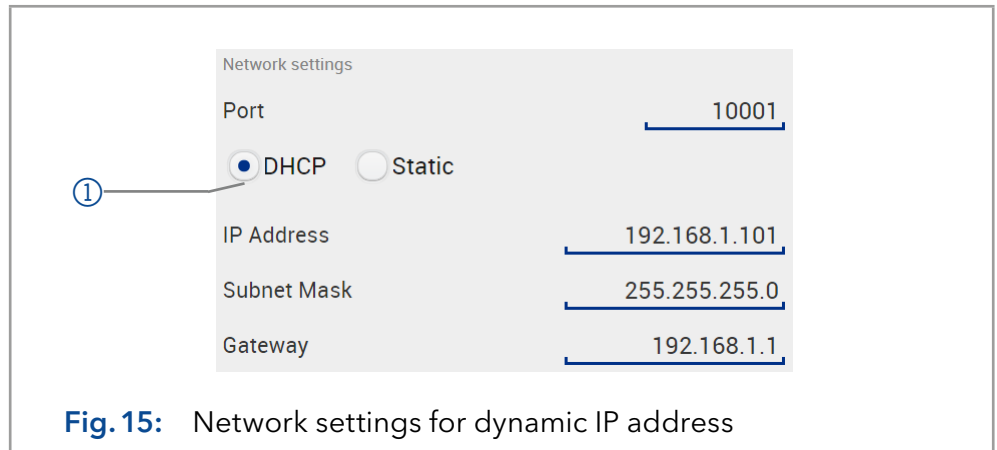



Fig. 15: Network settings for dynamic IP address

Result The device is now accessible via a dynamic IP address.

4.9.3 Mobile Control: Setting a dynamic IP address via device serial number

- Prerequisites**
- The device is switched on.
 - Mobile Control is installed and running.
 - The connection between Mobile Control and the device has been established.

Process

- Procedure**
1. In Mobile Control, click  <Settings>.
 2. In <Network Settings>, click <Reset>. The windows <Reset communication settings> opens.
 3. Enter the serial number of the device into the text field.
 4. Click <OK>. The device is now reset to default settings.
 5. Restart the device (recommended).

Result The device is now accessible via a dynamic IP address.

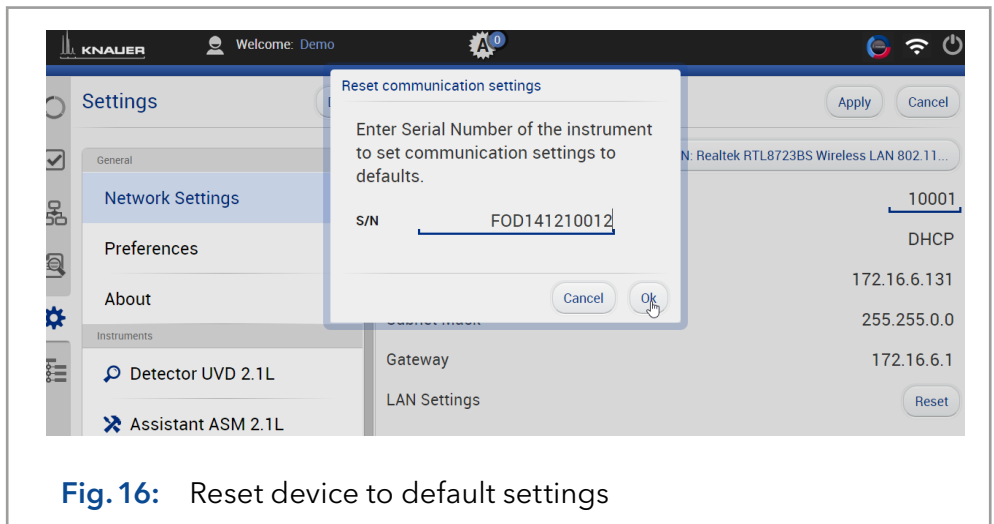

Fig. 16: Reset device to default settings

4.9.4 Firmware Wizard: Setting a static IP address



Note: More information about LAN settings can be found in the Mobile Control Software Instructions in the chapter "Firmware Wizard" (document no. V6851).

Legend:

- ① Text box for serial number of the device
- ② Setting IP address manually
- ③ Text box for IP address
- ④ Text box for subnet mask and gateway
- ⑤ Confirm changes

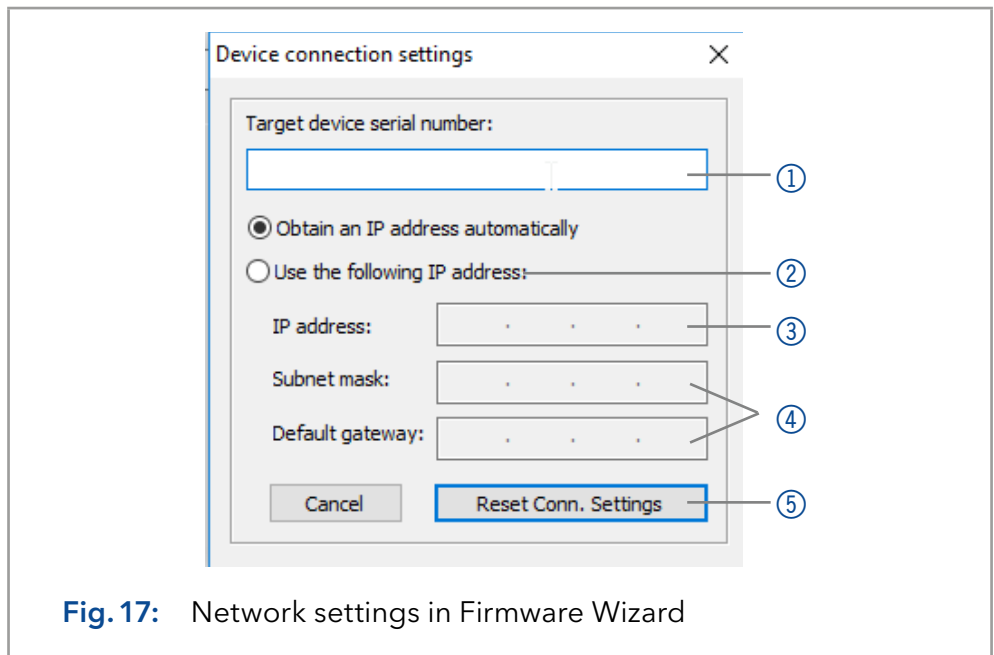

Fig. 17: Network settings in Firmware Wizard

Prerequisites

- The device is switched on.
- Firmware Wizard is installed and running.

Process

Procedure

1. In Firmware Wizard, click <Reset LAN Settings...>.
2. The window <Device connection settings> opens. Enter serial number of the device into the text field <Target device serial number> ①.
3. Select option <Use the following IP address> ②.
4. Enter the IP address into the text field <IP address> ③.

Process

5. Optionally, adjust subnet mask and gateway ④ .
6. Click <Reset Conn. Settings> ⑤ to accept changes.
7. Restart the device (recommended).

Result The device is now accessible via the static IP address.

4.9.5 Firmware Wizard: Setting a dynamic IP address

Prerequisites

- The device is switched on.
- Firmware Wizard is installed and running.

Process**Procedure**

1. In Firmware Wizard, click <Reset LAN Settings...>.
2. The window <Device connection settings> opens. Enter serial number of the device into the text field <Target device serial number> ① .
3. Select option <Obtain an IP address automatically> ② .
4. Click <Reset Conn. Settings> ⑤ to accept changes.
5. Restart the device (recommended).

Result The device is now accessible via a dynamic IP address.

4.10 Remote control

- For receiving start, control, and error signals from external devices
- For sending start, control, and error signals to external devices

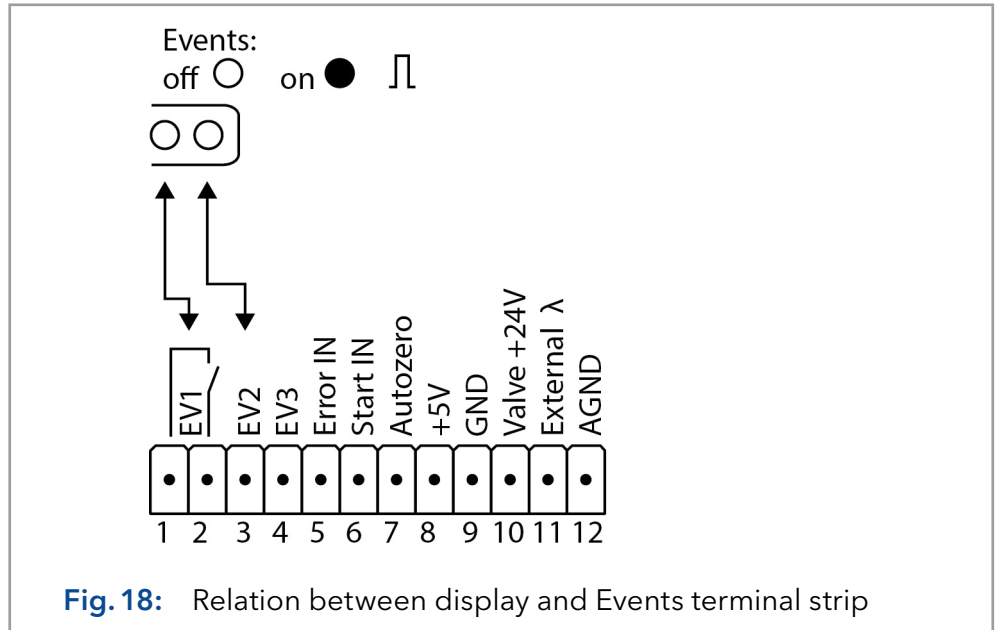

Fig. 18: Relation between display and Events terminal strip

4.10.1 Connector assignment

Plug	Function
EV 1 (Event 1)	<p>Relay contact</p> <ul style="list-style-type: none"> ■ The contact is on a floating basis. Its setting depends on the settings in the software. ■ Steady-rate signal: <ul style="list-style-type: none"> - passive = open relay contact - active = closed relay contact ■ Pulse: <ul style="list-style-type: none"> - closed relay contact for at least 1000 ms - permissible load of the relay contact: 1 A/24 V DC
EV 2 (Event 2)	<p>TTL compatible output</p> <ul style="list-style-type: none"> ■ Levels: <ul style="list-style-type: none"> - passive 5 V - active 0 V ■ Pulse: <ul style="list-style-type: none"> - 0 V for at least 1000 ms
EV 3 (Event 3)	<p>TTL compatible output</p> <ul style="list-style-type: none"> ■ Levels: <ul style="list-style-type: none"> - passive 5 V - active 0 V ■ Pulse: <ul style="list-style-type: none"> - 0 V for at least 1000 ms

Plug	Function
Error IN	TTL input <ul style="list-style-type: none"> Low active Secure switching threshold at least 10 mA After receiving a signal (short circuit to ground) from an external device, an error message appears and the device stops.
Start IN	TTL Input <ul style="list-style-type: none"> Low active Secure switching threshold at least 10 mA After receiving a signal (short circuit to ground) from an external device, the device starts. If controlled via software, an electronic trigger is sent via LAN.
Autozero	<ul style="list-style-type: none"> Low active Secure switching threshold at least 10 mA A signal (short circuit to ground) sets the measuring signal to zero.
+5V	<ul style="list-style-type: none"> Provides a voltage of 5 V with respect to GND. This makes it possible to supply an appliance that is switched by an EVENT. Max. current: 50 mA
GND	Reference point of the voltage at the signal inputs.
+24V Valve	<ul style="list-style-type: none"> Event controlled switching of 24 V against GND Max. current: 200 mA
External λ	<ul style="list-style-type: none"> Allows external analog control of the detector when the option ANALOG has been selected in the SETUP menu. The control voltage must be applied against AGND. Voltage range: 0-10 V The scaling can be changed by the user.
AGND	Reference point of the voltage at the input external λ .

4.10.2 Analog control

Using the analog port, you can control the wavelength by changing the applied voltage. A Mobile Control is required in order to select the option ANALOG in the SETUP menu.

Example To use the analog port for controlling the detector, you have to set a zero point and enter a scaling value.

- Zero point at 0 V = 000 nm
- Scaling: 100 nm per Volt

If 5 V voltage is applied, the wavelength is 500 nm.

4.10.3 Integrator connector

The integrator connector sends measuring signals from the detector.

- non-bipolar
- 1 channel
- 0 to 5 V
- DAC 20 bit
- scalable
- adjustable to offset

4.10.4 Connecting the pin header

To control one device through another, the pin header is used. To use remote control, you have to connect cables to the pin header. The single ports are used to exchange control signals.

- Prerequisites**
- The device is switched off.
 - The power plug is disconnected from the device.
- Tools**
- Operating tool

NOTICE

Electronic defect

Connecting cables to the multi-pin connector of a switched on device causes a short circuit.

- Turn off the device before connecting cables.
- Pull the power plug.

NOTICE

Electronic defect

Electrostatic discharge can destroy the electronics.

- Wear a protective bracelet against electrostatic discharge and ground.

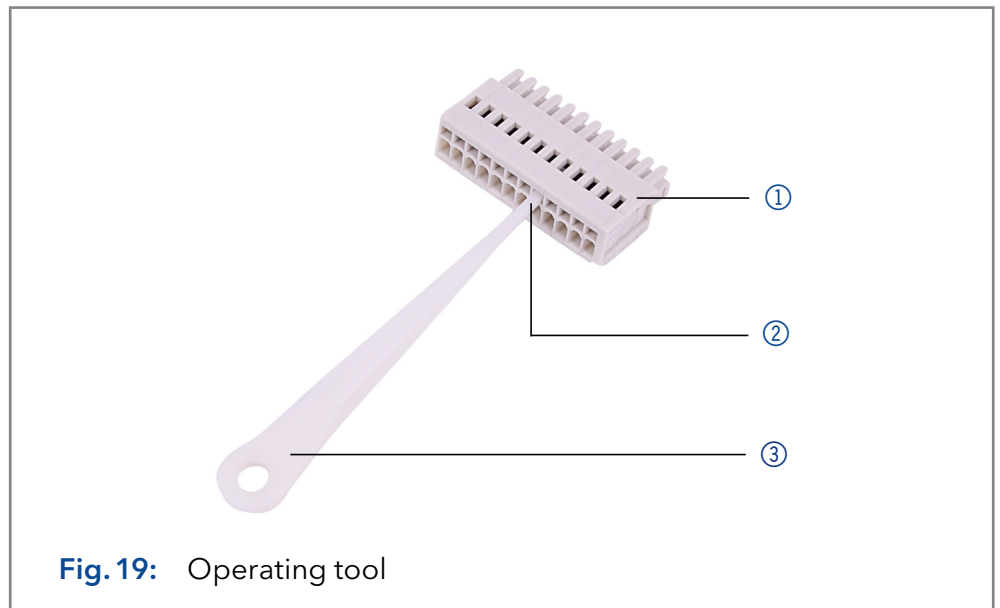

Fig. 19: Operating tool

Process

1. Insert the operating tool ③ in an upper small opening at the front of the pin header ①.
2. Insert the cable into the opening ② underneath the inserted operating tool.
3. Pull out the operating tool.

Next steps

- Check whether the cables are tightly attached.
- Press the pin header onto the connector.
- Finish the installation.
- Bring the device into operation.

4.11 Switching on

The device is switched on by the power key on the back of the device.

Prerequisite

- Installation has been completed.
- Flow cell is mounted on the detector.

Steps

Figure

Procedure

1. Insert the plug into the female connector ② at the rear panel.
2. Plug the other end into an electric socket.
3. Switch on the device at the power switch ①.

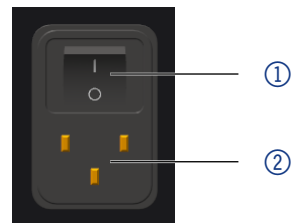

Fig. 20 Power switch with female connector

Result

The detector starts its self calibration. The end of the self calibration is indicated by the flashing of the status LED. If the self calibration fails, switch the detector off and on again.

5. Operation



Note: Before the detector is ready to use for measurements, a flow cell must be installed. You can change the optical path length of a preparative flow cell before assembling the flow cell. The optimal path length depends on type and quantity of the sample.

5.1 Checklist before operation

- Device is in a location which suits the ambient conditions and space requirements specified in section „Ambient conditions“ on page 12.
- The power connection of the detector is plugged in (see „4.3 Power supply“, p. 13).

If the detector is part of a HPLC system, the following must be observed:

- The network connection to the router is established (see „4.8.4 Configuring the router“, p. 19).
- A chromatography software has been installed by KNAUER or a company authorized by KNAUER.
- Capillaries from the column to the UV detector and capillaries from the detector to the waste bottle are securely attached.

5.2 Software control

A device can be operated in several ways:

- With chromatography software
- With KNAUER Mobile Control



Note: It is not possible to use two operating methods simultaneously. If the device is connected to the software, it cannot be controlled via Mobile Control. The device status can however be monitored.

5.2.1 Chromatography software

To control the device with chromatography software, it must be connected to the computer through the LAN interface.

Devices can be controlled with e. g. OpenLAB® EZChrom edition version A.04.05 or higher, ChromGate version 3.3.2 or higher and ClarityChrom® version 3.0.7 or higher, Chromeleon® 7.2 and PurityChrom® version 5.07.039 or higher.

You will find a detailed description on the chromatography software in the software instructions.

5.2.2 Mobile Control

The Mobile Control is a device control software which can be installed on your computer or tablet. To control the device using the Mobile Control, connect the computer or tablet to a wireless LAN router. Data transfer between device and Mobile Control is actualized through wireless LAN. You find a detailed description on the Mobile Control in its accompanying instructions.

5.3 Setting the wavelength

You can set a wavelength between 190–750 nm.

5.4 Resetting the device

Using the Mobile Control, you can reset the detector to its default settings.

Parameter	Settings
Network	LAN DHCP, port 10001
Lamps	D2 ON
Time constant	2 s
Channels	Channel 1: WL = 254 nm
Analog out	Offset 1 = 10 mV, Scale 1 = 1 AU/V
Event check	All events deactivated (o)
Date/Time	Current date/time
Fraction collector	OFF
Leak sensor	ON, sensitivity = low

6. Functionality tests



Note: Standard processes regarding IQ and OQ in single devices may be handled differently in individual cases.

6.1 Installation Qualification (IQ)

The customer may request the Installation Qualification, which is free of charge. In case of a request, the technical support of KNAUER or a provider authorized by KNAUER performs this functionality test during the installation.

The Installation Qualification is a standardized document that includes the following:

- Confirmation of flawless condition at delivery
- Check if the delivery is complete
- Certification on the functionality of the device

You can either use the IQ document attached to this instruction manual or download a digital version from our website:



6.2 Operation Qualification (OQ)

The Operation Qualification includes an extensive functionality test according to KNAUER standard OQ documents. The Operation Qualification is a standardized document and free of charge. It is not part of the delivery. Please contact the technical support in case of a request.

The Operation Qualification includes the following:

- Definition of customer requirements and acceptance terms
- Documentation on device specifications
- Device functionality check at installation site

Test intervals To make sure that the device operates within the specified range, you should test the device regularly. The test intervals depend on the usage of the device.

Execution The test can be carried out either by the technical support of KNAUER or by a provider authorized by KNAUER (for a fee). For further information visit our website:



7. Troubleshooting

First measures:

- Check all cables and fittings.
- Check if air has gotten into the supply lines.
- Check the device for leakages.
- Check system messages in the software (see „7.3 System messages“, p. 34).

Further measures:

- Compare occurring errors with the list of possible errors (see below).
- Contact with the Customer Support.

7.1 LAN

Go through the following steps, in case no connection between the computer and the devices can be established. Check after each step if the problem is solved. If the problem cannot be located, call the Technical Support.

1. Check the status of the LAN connection in the Windows task bar:



If no connection was established, test the following:

- Is the router switched on?
 - Is the patch cable connected correctly to the router and the computer?
2. Check the router settings:
 - Is the router set to DHCP server?
 - Is the IP address range sufficient for all the connected devices?
 3. Check all connections:
 - Are the patch cables connected to the LAN ports and not the WAN port?
 - Are all cable connections between devices and router correct?
 - Are the cables plugged in tightly?
 4. If the router is integrated into a company network, pull out the patch cable from the WAN port.
 - Can the devices communicate with the computer, even though the router is disconnected from the company network?
 5. Turn off all devices, router, and computer. First switch on the router and wait until it has successfully completed its self-test. Firstly, turn on the router and secondly, turn on the devices and the computer.
 - Has this been successful?
 6. Replace the patch cable to the device with that no connection could be established.
 - Has this been successful?
 7. Make sure that the IP port of the device matches the port in the chromatography software.

7.2 Possible problems and solutions

Problem	Solution
Baseline drift	Maintain constant temperature conditions during the measurement.
Device will not turn on.	Inspect the power cable to ensure that it is plugged into the power supply.
Device cannot be calibrated.	<ol style="list-style-type: none">1. Fasten the knurled-head screws on the slide to prevent incursion from interfering light or an electronics error.2. Insert the test cell.3. Inspect the calibration with a weak absorbing eluent.
Baseline noise	<ol style="list-style-type: none">1. Inspect the flow cell assembly.2. Fasten the knurled-head screws on the slide to prevent incursion from interfering light or an electronics error.3. Exchange the defective flow cell.4. Inspect the service life of the lamp on the display.5. Reduce the air in the flow cell with a degasser.
The relationship of the signal to the light path reference is very low.	<ol style="list-style-type: none">1. Flush the flow cell.2. Clean the flow cell window.3. Replace the lamps.

7.3 System messages

If other system messages are displayed besides those listed below, please turn the device off and then on. Inform the Customer Support in case the system message repeats.

The system messages are in alphabetical order:

Message	Measure
Calibration failed	<ol style="list-style-type: none"> 1. Restart the device. 2. Check whether lamps, motor and filter are functioning correctly. 3. Restart calibration on the device or in the chromatography software.
Calibration failed - Filter position error	<p>The filter wheel moves incorrectly.</p> <ul style="list-style-type: none"> ■ Restart the device.
Calibration failed - Low light	<p>Both reference channel and signal channel do not have enough light for the calibration due to, for instance, a defective lamp.</p> <ul style="list-style-type: none"> ■ Restart the device.
Calibration failed: Signal path open	Restart the device.
Calibration failed: Too much light	Restart the device.
Cannot delete active program/link	<ol style="list-style-type: none"> 1. Pause link. 2. Delete program.
Cannot edit program from the running link	<ol style="list-style-type: none"> 1. Pause link. 2. Edit data using chromatography software.
Cannot initialize LAN	Check cables and connections in local area network.
Cannot operate an uncalibrated instrument	<ol style="list-style-type: none"> 1. Restart the device. 2. Wait until calibration is completed.
Cannot operate with an empty link	Create a link.
Cannot proceed: D2 lamp heating	Restart the device. If the error occurs again, replace the lamp.
Cannot proceed: D2 lamp is OFF!	<ol style="list-style-type: none"> 1. Switch the lamp on. If the error occurs again, restart the device. 2. If the lamp is off after restarting, replace the lamp.

Message	Measure
Cannot proceed: lamps are off.	<ol style="list-style-type: none"> 1. Switch the lamp on. If the error occurs again, restart the device. 2. If the lamp is off after restarting, replace the lamp.
Cannot read data from FRAM	Restart the device.
Cannot read RTC	Restart the device.
Cannot write data on FRAM	Delete the programs.
D2 lamp operation failed	<ol style="list-style-type: none"> 1. Restart the device. 2. If the error occurs again, replace the lamp.
D2 lamp does not start	<ol style="list-style-type: none"> 1. Restart the device. 2. If the error occurs again, the lamp unit has to be replaced. Contact the Customer Support.
Data acquisition active	<p>No entries are possible.</p> <ul style="list-style-type: none"> ■ Stop acquiring measurement data, then you can make a new entry.
Filter move error	Restart the device.
GUI communication failed	Restart the device.
Instrument remote controlled	<p>This entry is not executable.</p> <ul style="list-style-type: none"> ■ Close and exit the software.
Invalid command	<ol style="list-style-type: none"> 1. Check the cable connections. 2. Change the entry.
Invalid line number	Change the entry in the program line.
Invalid link	Reconfigure the link.
Invalid parameter(s)	Check the validity of the parameters.
Invalid time in time table	Correct the time entry.
Invalid index in time table	Change the entry in the program line.
Leak sensor not present	Restart the device.
Leak was detected	<ol style="list-style-type: none"> 1. Switch off the device. 2. Remove the leak. 3. Switch on the device.
Link does not exist	Create a link.

Message	Measure
Link is running	<ol style="list-style-type: none"> 1. Wait until the link has been completed. 2. Change the link or delete it.
Motor end position reached Instrument will be recalibrated	<p>The motor that controls the wavelength reached its end position and stopped.</p> <ul style="list-style-type: none"> ■ Recalibrate the device.
Motor failure	Restart the device.
No link available	Create a link.
Not enough space to store link	<p>A maximum of 50 link lines are possible.</p> <ul style="list-style-type: none"> ■ Check the number of link lines.
Not enough space to store program	<p>A maximum of 50 program lines are possible.</p> <ul style="list-style-type: none"> ■ Check the number of program lines.
Operation time out	Restart the device.
Program does not exist	Create a program.
Program is running	Quit program or wait until program has been completed.
This link is used in WAKEUP	<ol style="list-style-type: none"> 1. Quit or delete wakeup program (wu = Wake Up). 2. Edit or delete link.
This program is used in a link	<ol style="list-style-type: none"> 1. Pause or delete the link. 2. Edit or delete data by means of the chromatography software.
This program is used in WAKEUP	<ol style="list-style-type: none"> 1. Quit or delete wakeup program (wu = Wake Up). 2. Edit or delete data by means of the chromatography software.
Time already exists	Correct the time entry.
Too many lines in program	<p>A maximum of 50 program lines are possible.</p> <ul style="list-style-type: none"> ■ Check the number of program lines.
Wake up time already passed!	Specify new time.

8. Maintenance and care

Maintenance of a HPLC instrument is critical to the success of analyses and the reproducibility of results. If you require a maintenance task which is not described here, contact your dealer or the Customer Support.

8.1 Maintenance tasks

DANGER

Electric shock

High voltages inside the detector pose a life threatening risk.

- Only authorized service technicians are allowed to remove the housing and to replace the lamp.

WARNING

Eye injury

Eye irritation by UV light. Bundled UV light can escape from the flow cell or fiber optic cables.

- Switch off the detector and disconnect it from the power supply.

NOTICE

Electronic defect

Performing maintenance tasks on a switched on device can cause damage to the device.

- Switch off the device.
- Pull the power plug.

Users may perform the following maintenance tasks themselves:

- Regularly check the light intensity of the D₂ lamp (best before 2 000 operating hours).
- Inspect the flow cell assembly.
- Clean the flow cell.
- Replace the flow cell.

8.1.1 Maintenance contract

The device may only be opened by the Technical Service of KNAUER or any company authorized by KNAUER. These maintenance tasks are part of a separate maintenance contract.

8.2 Cleaning and caring for the device

NOTICE

Device defect

Intruding liquids can cause damage to the device.

- Place solvent bottles next to the device or in a solvent tray.
- Moisten the cleaning cloth only slightly.

All smooth surfaces of the device can be cleaned with a mild, commercially available cleaning solution, or with isopropanol.

8.3 Replacing the flow cell

UV light will cause the flow cells to become blind with time (solarization), making them no longer suitable for use.

Prerequisite

- Detector is switched off.
- Power plug is disconnected from the device.
- Capillaries are disconnected.

Steps

1. Unscrew the knurled-headscrews ①.

2. Pull out the slide ②.

3. Remove the flow cell.

4. Insert the flow cell ③ into the slide.

5. Push the slide into the detector ②.

6. Insert the knurled-head screws and screw tight.

Figure

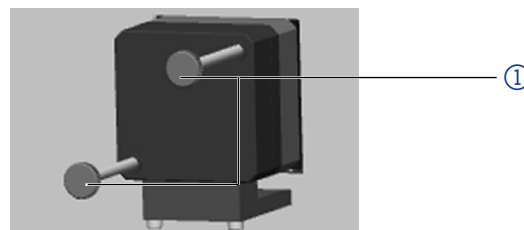

Fig.21 Removing the screws

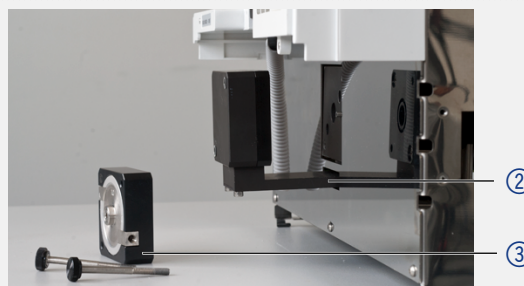

Fig.22 Assembling the flow cell

Result The flow cell is assembled.

Next step Connect the capillaries.

8.4 Cleaning the flow cell

Increased baseline noise and reduced sensitivity can be a result of a dirty flow cell. Often it is sufficient to rinse the flow cell to restore optimal sensitivity.



Note: Dirty lenses or fiber optic connectors could falsify the measurement. Do not touch the lens or the fiber optic connector lenses with bare hands. Wear gloves.

8.4.1 Rinsing the flow cell

NOTICE

Performance decrease

For the drying step, oil drops from compressed air can contaminate the flow cell which may result in performance decrease.

→ Do not use compressed air for drying.

- Prerequisite**
- Flow cell is removed from the detector.
 - Waste tube is connected to the flow cell.

Solvents The following solvents are recommended for rinsing:

- Diluted HCl (1 mol/l)
- 1 ml/l NaOH aq.
- Ethanol
- Acetone

Tools Syringe

Procedure

Process

1. Fill the syringe with eluent.
2. Inject it into the inlet of the flow cell and allow it to act for 5 minutes.
3. Fill the syringe with water and rinse the inlet.
4. Use a nitrogen stream to dry the flow cell.

Result The flow cell is rinsed.

- Next steps**
- Check if the baseline noise has decreased.
 - If the rinsing does not have the desired effect, disassemble the flow cell to clean the lens.

8.4.2 Cleaning the lens of an analytical flow cell

Prerequisite Flow cell is removed from the detector.

- Tools**
- Tweezers
 - Allen screwdriver, size 3

Legend:

- ① Threaded ring
- ② Compression part
- ③ Lens
- ④ Seal ring

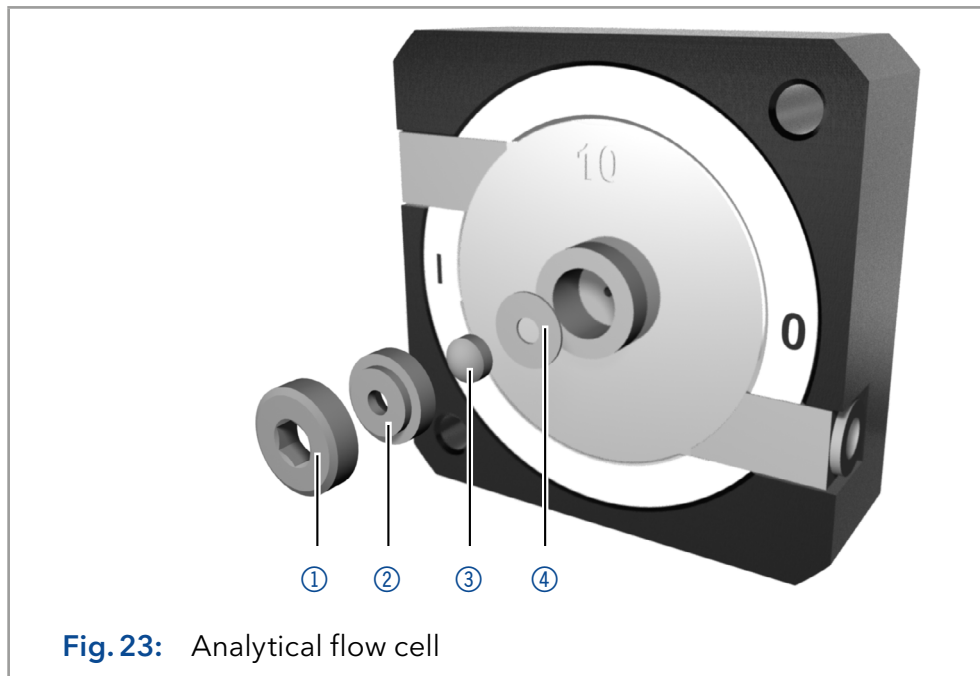

Fig. 23: Analytical flow cell

Procedure

Process

1. Using the allen screwdriver, loosen the threaded ring ①.
2. Using tweezers or by gently tapping on a clean surface, remove the compression part ②.
3. The lens ③ is protected by a seal ring ④. This must be renewed every time the lens is disassembled.
4. Remove the lens and clean with a clean, soft cloth or with water in an ultrasonic bath.
5. Assemble the flow cell. Make sure that the new seal ring does not interrupt the light path.
6. Using the allen screwdriver, tighten the threaded ring ① with a torque of 1 Nm.

Result The flow cell lens is clean.



Note: If the cleaning of the lens does not have the desired effect, the lens has to be replaced.

Next step Mount the flow cell onto the detector.

8.4.3 Cleaning the light guide of a preparative flow cell

The preparative flow cells have a rod shaped light guide instead of the concave lens of the analytical cells.

Prerequisite Flow cell is removed from the detector.

Tools

- Tweezers
- Allen screwdriver, size 3

Legend:

- ① Threaded ring
- ② Cover
- ③ Spacer
- ④ Compression bushing
- ⑤ Light guide with seal ring

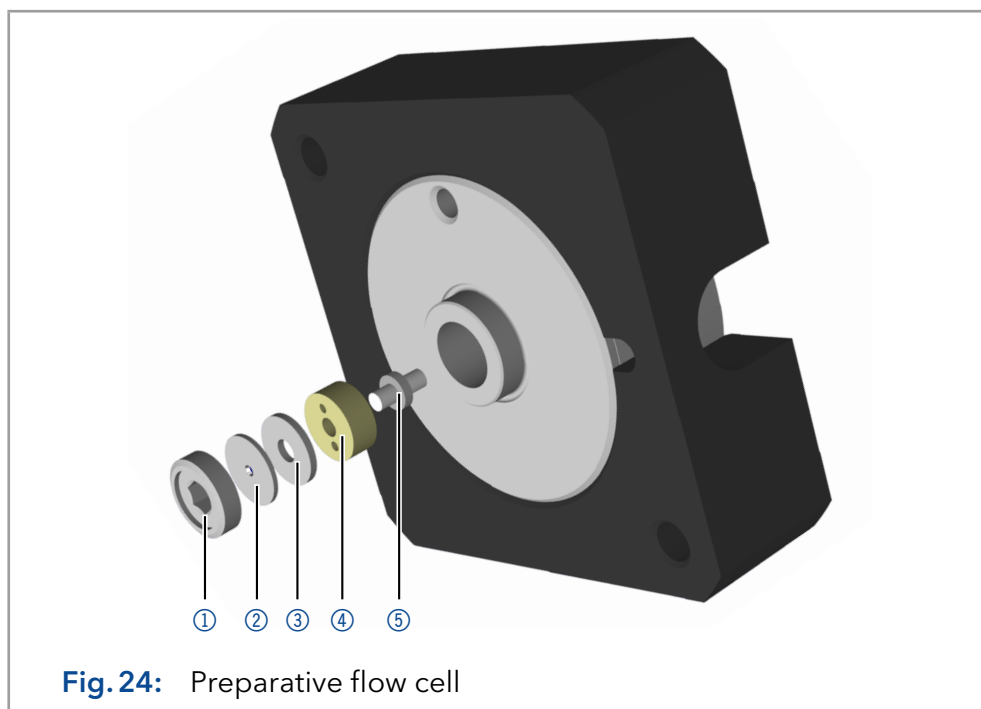

Fig. 24: Preparative flow cell

Procedure

Process

1. Using the allen screwdriver, loosen the threaded ring ①.
2. Remove the cover ② and the spacer ③ (not part of all flow cells).
3. Using tweezers, pull out the compression bushing ④ and the light-guide ⑤.
4. Carefully push the light guide out of the holder and strip off the seal. The seal ring needs to be renewed during every cleaning of the fiber optics.
5. Clean the light guide with a clean, soft cloth or with an appropriate solvent in an ultrasonic bath. Make sure that the clean light guide is not touched by fingers.
6. Assemble the flow cell. Make sure that the new seal ring does not interrupt the light path.
7. Using the allen screwdriver, tighten the threaded ring ① with a torque of 1.1 Nm.

Result The flow cell light guide is clean.



Note: If the cleaning of the light guide does not have the desired effect, replace the light guide.

Next step Mount the flow cell onto the detector.

8.5 Replacing the fiber optics

UV light will cause the fiber optics to become blind with time (solarization), making them no longer suitable for use.





Note: Observe the following regarding the use of fiber optics:

- Do not touch the ends of the fiber optics with your fingers, as this could falsify the measurement.
- Handle the fiber optics with care and avoid impacts.
- Move the fiber optics carefully without using pressure or bending it.

Prerequisite Detector is switched off.

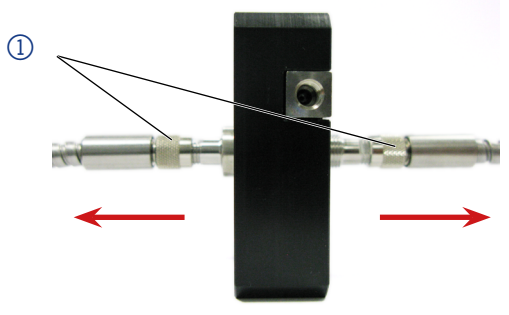
Tools Cap fittings for fiber optics

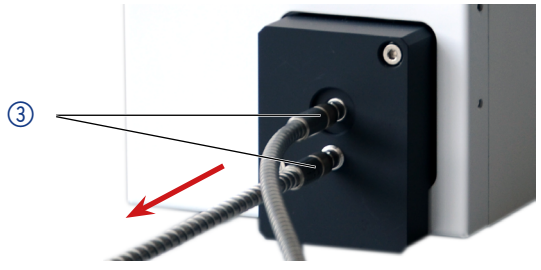
Steps	Figure
<p>1. To detach from the flow cell, unscrew the fittings of the fiber optics manually ①.</p>	 <p>Fig.25 Fiber optics fittings on flow cell</p>
<p>2. Seal the fiber optic connectors with caps ②.</p>	 <p>Fig.26 Cap for optic connector</p>
<p>3. Manually, unscrew the fiber optics ③ from the detector.</p> <p>4. To mount new fiber optics onto the flow cell, repeat step 1-3 in reverse order.</p>	 <p>Fig.27 Fiber optics on the detector</p>

Result The fiber optics are replaced.

9. Transport and storage

Regarding the following information, carefully prepare the device for transport or storage.

9.1 Taking the device out of operation

Prerequisites The device is switched off.

Procedure

Process

1. Pull the power plug out of the socket and then out of the device.
2. Pack the power cable together with the device.

Next steps

- Disconnect all electrical connections.
- Remove the accessories.
- Pack the device for transport or storage.

9.2 Packing the device

- Original packaging: Ideally you should use the original transport packaging.
- Lifting: Grab the device around the center of both sides and lift it into the packaging. Do not hold onto front cover or leak tray, as these parts are loosely attached to the device.

9.3 Transporting the device

- Documents: If you want to return your device to KNAUER for repairs, enclose the Service Request Form and Decontamination Report which can be downloaded from our website: www.knauer.net/servicerequest
- Device data: For a secure transport, note the weight and dimensions of the device (see „11 Technical data“, p. 45).

9.4 Storing the device

- Flushing solution: Pay attention that all hoses and capillaries have been emptied or filled with flushing solution (e. g. isopropanol) before storage. To prevent algae formation, do not use pure water.
- Seals: Close all inputs and outputs with cap fittings.
- Ambient conditions: The device can be stored under suitable ambient conditions (see „11 Technical data“, p. 45).

10. Disposal

Hand in old devices or disassembled old components at a certified waste facility, where they will be disposed of properly.

10.1 AVV-Marking Germany

According to the German "Abfallverzeichnisverordnung" (AVV) (January, 2001), old devices manufactured by KNAUER are marked as waste electrical and electronic equipment: 160214.

10.2 WEEE registration number

KNAUER as a company is registered by the WEEE number DE 34642789 in the German "Elektroaltgeräteregister" (EAR). The number classifies to category 8 and 9, which, among others, comprises laboratory equipment.

All distributors and importers are responsible for the disposal of old devices, as defined by the WEEE directive. End-users can send their old devices manufactured by KNAUER back to the distributor, the importer, or the company free of charge, but would be charged for the disposal.

10.3 Eluents and other operating materials

All eluents and other operating materials must be collected separately and disposed of properly.

All wetter components of a device, e. g. flow cells of detectors or pump heads and pressure sensors for pumps, have to be flushed with isopropanol first and water afterwards before being maintained, disassembled or disposed.

11. Technical data

11.1 Detection

Detector type	<ul style="list-style-type: none"> ■ Variable single wavelength UV/VIS detector ■ Variable single wavelength UV/VIS detector with fiber optic connectors
Detection channels	1
Light source	Deuterium (D ₂) lamp with integrated GLP chip
Wavelength range	190–750 nm
Spectral bandwidth	11 nm at H _α line (FWHM)
Wavelength accuracy	± 2.5 nm
Wavelength precision	0.3 nm (ASTM E275-93)
Noise	<ul style="list-style-type: none"> ■ ± 1.5 × 10⁻⁵ AU at 254 nm (ASTM E1657-98) ■ Fiber optics version: ± 2.0 × 10⁻⁵ AU at 254 nm (ASTM E1657-98)
Drift	<ul style="list-style-type: none"> ■ 3.0 × 10⁻⁴ AU/h at 254 nm (ASTM E1657-98) ■ Fiber optics version: 4.0 × 10⁻⁴ AU/h at 254 nm (ASTM E1657-98)
Linearity	> 2.0 AU at 274 nm (ASTM E1657-98)
Time constraints	0.0 / 0.1 / 0.2 / 0.5 / 1.0 / 2.0 / 5.0 / 10.0 s
Integration time	Automatic

11.2 Communication

Max. data rate	50 Hz (LAN), 20 Hz (analog)
Interfaces	<ul style="list-style-type: none"> ■ LAN (RJ-45) ■ RS-232 (SUB-D 9, service only) ■ Pin header ■ Analog (RCA cinch connector)
Control	<ul style="list-style-type: none"> ■ Mobile Control ■ Chromatography software ■ Event control ■ Analog ■ Terminal protocol
Inputs	<ul style="list-style-type: none"> ■ Error (IN) ■ Start (IN) ■ Autozero ■ 0–10 V Analog IN

Outputs	<ul style="list-style-type: none"> ■ Event 1-3 ■ +5 V ■ +24 V valve
Analog input	Wavelength 0-10 V
Analog output	1 x 0-5 V scalable, 20 bit, offset adjustable

11.3 General

Dimensions (W × H × D)	361 × 158 × 523 mm
Weight	<ul style="list-style-type: none"> ■ 5.9 kg ■ 6.0 kg (fiber optics version)
Leak sensor	Yes
GLP	Detailed report including lamp recognition, operating hours, lamp operating hours, number of lamp ignitions
Display	Mobile Control (optional)
Power supply	100-240 V, 50-60 Hz, 65 W
Max. power input	100 W
Temperature range	4-40 °C, 39.2-104 °F
Area of use	For indoor use only
Line voltage fluctuations do not exceed ± 10 % of normal voltage.	
Overvoltage category	II
Permitted pollution degree	2
Air humidity	Below 90 %, non-condensing
Operating height	Max. 2000 meters above sea level

12. Reorders

The list of repeat orders is current at the time of publication. Deviations at a later time are possible. Use the enclosed packing list for reordering spare parts. If you have any questions regarding spare parts or accessories, please contact our Customer Support.

Further information Current information on spare parts and accessories can be found on the Internet at www.knauer.net.

12.1 Devices

Name	Order no.
AZURA® UV/VIS Detector UVD 2.1L, without flow cell	ADA01XA
AZURA® UV/VIS Detector UVD 2.1L, fiber optics version, without flow cell	ADA04XA

12.2 Accessories and spare parts

Name	Order no.
AZURA® tool kit	A1033
Spare part kit for analytical flow cells	A1131
Spare part kit for preparative flow cells	A1132
Accessories kit	FDA
AZURA® accessories kit	FZA02
Deuterium lamp	A5193

12.3 Fiber optic connectors

Name	Order no.
2 × fiber optic connector 750 mm	A0740
2 × fiber optic connector 750 mm, high temperature up to 85 °C	A0740HT
2 × fiber optic connector, custom made size	A0743

12.4 Flow cells

Most flow cells are also available equipped with fiber optic connectors for the use with the fiber optics version of the detector.

12.4.1 Analytical flow cells

Technical data		Order No.
Path length	10 mm	A4061XB
Connection	1/16"	Fiber optics version:
Inner diameter	1.1 mm	A4074
Volume	10 µl	
Material	Stainless steel with heat exchanger	
Max. flow rate	20 ml/min	
Max. pressure	300 bar	
Path length	3 mm	A4042
Connection	1/16"	Fiber optics version:
Inner diameter	1.0 mm	A4044
Volume	2 µl	High temperature
Material	Stainless steel	fiber optics version:
Max. flow rate	50 ml/min	A4044HT
Max. pressure	300 bar	
Max. temperature	85 °C (A4044HT only)	
Path length	3 mm	A4045
Connection	1/16"	Fiber optics version:
Inner diameter	1.0 mm	A4047
Volume	2 µl	
Material	PEEK	
Max. flow rate	50 ml/min	
Max. pressure	30 bar	

12.4.2 Preparative flow cells

Technical data		Order No.
Path length	0.5 / 1.25 / 2 mm	A4066
Connection	1/8"	Fiber optics version:
Inner diameter	2.3 mm	A4078
Volume	1.7 / 4.3 / 6.8 µl	
Material	Stainless steel	
Max. flow rate	1 000 ml/min	
Max. pressure	200 bar	
Path length	0.5 / 1.25 / 2 mm	A4067
Connection	1/8"	Fiber optics version:
Inner diameter	2.3 mm	A4079
Volume	1.7 / 4.3 / 6.8 µl	
Material	PEEK	
Max. flow rate	1 000 ml/min	
Max. pressure	100 bar	

Technical data		Order No.
Path length	0.5 / 1.25 / 2 mm	A4068 (angular connections)
Connection	1/4"	A4068-2 (straight connections)
Inner diameter	4.0 mm	Fiber optics version: A4081 (angular connections)
Volume	1.7 / 4.3 / 6.8 µl	A4081V2 (straight connections)
Material	Stainless steel	
Max. flow rate	10 000 ml/min	
Max. pressure	200 bar	
Path length	0.5 mm	A4069
Connection	1/16"	Fiber optics version: A4089
Inner diameter	0.8 mm	
Volume	3 µl	
Material	Stainless steel	
Max. flow rate	250 ml/min	
Max. pressure	200 bar	
Path length	0.5 mm	A4095
Connection	1/16"	Fiber optics version: A4096
Inner diameter	0.8 mm	
Volume	3 µl	
Material	PEEK	
Max. flow rate	250 ml/min	
Max. pressure	100 bar	

12.4.3 Preparative flow cells - fiber optics

Technical data		Order No.
Path length	10 mm	A4154-1
Capillary connection	3/8" with Tri-Clamp	
Material	PEEK	
Max. flow rate	10 000 ml/min	
Max. pressure	10 bar	
Path length	7 mm	A4152-1
Capillary connection	3/8" with Tri-Clamp	
Material	PEEK	
Max. flow rate	10 000 ml/min	
Max. pressure	10 bar	
Path length	0.5 / 1.25 / 2 mm	A4154
Capillary connection	1/2" with Tri-Clamp	
Material	Stainless steel	
Max. flow rate	10 000 ml/min	
Max. pressure	80 bar	
Path length	0.5 / 1.25 / 2 mm	A4155
Capillary connection	3/4" with Tri-Clamp	
Material	Stainless steel	
Max. flow rate	10 000 ml/min	
Max. pressure	80 bar	

Technical data		Order No.
Path length	0.5 / 1.25 / 2 mm	A4152
Capillary connection	3/8" with Tri-Clamp	
Material	Stainless steel	
Max. flow rate	10 000 ml/min	
Max. pressure	80 bar	
Path length	0.5 / 1.25 / 2 mm	A4153
Capillary connection	1/4" with Tri-Clamp	
Material	Stainless steel	
Max. flow rate	10 000 ml/min	
Max. pressure	80 bar	

12.4.4 Test cells

Technical data		Order No.
Test cell	Normal	■ A4123
		■ Fiber optics version: A4125
Test cell	Holmium oxide filter	■ A4126
		■ Fiber optics version: A4128
Test cell	Stray light filter	■ A4146
		■ Fiber optics version: A4148

13. Chemical compatibility of wetted materials



Note: The user takes the responsibility for using the fluids and chemicals in an appropriate and safe way. If there is any doubt, contact the Technical Support of the manufacturer.

13.1 General

The device is very resistant against a variety of commonly used eluents. However, make sure that no eluents or water come in contact with the device or enter into the device. Some organic solvents (such as chlorinated hydrocarbons, ether) may cause coating damage or loosen glued components by improper handling. Even small quantities of other substances, such as additives, modifiers, or salts can influence the durability of the materials. Exposure time and concentration have a high impact on the resistance.

The following list contains information about the chemical compatibility of all wetted materials which are used in devices made by KNAUER. The data bases on a literature research on the manufacturer specifications of the materials. The wetted materials of this device are listed in the chapter "Technical data".

All resistances mentioned here are for use at temperatures up to 40 °C, unless stated otherwise. Please note that higher temperatures can significantly affect the stability of different materials.

13.2 Plastics

Polyetheretherketone (PEEK)

PEEK is a durable and resistant plastic and, next to stainless steel, the standard material in HPLC. It can be used at temperatures up to 100 °C and is highly chemical resistant against almost all commonly used solvents in a pH range of 1 - 12.5. PEEK is potentially moderate resistant against oxidizing and reducing solvents.

Therefore, following solvents should not be used: Concentrated and oxidizing acids (such as nitric acid solution, sulfuric acid), halogenated acids (such as hydrofluoric acid, hydrobromic acid) and gaseous halogens. Hydrochloric acid is approved for most applications.

In addition, following solvents can have a swelling effect and may have an impact on the functionality of the built-in components: Methylene chloride, THF and DMSO in any concentration such as acetonitrile in higher concentrations.

Polyethylene terephthalate (PET, outdated PETP)

PET is a thermoplastic and semi-crystalline material with high wear resistance. It is resistant against diluted acids, aliphatic and aromatic hydrocarbons, oils, fats and alcohols, but not against halogenated hydrocarbons and ketones. Since PET belongs chemically to esters, it is not compatible with inorganic acids, hot water and alkalis. Maximum operating Temperature: up to 120 °C.

Polyimide (Vespel®)

This material is wear-resistant and permanent resilient thermally (up to 200 °C) as well as mechanically. It is chemically broadly inert (pH range 1 - 10) and is especially resistant against acidic to neutral and organic solvents, but vulnerable to pH strong chemical or oxidizing environments: It is incompatible with concentrated mineral acids (such as sulfuric acid), glacial acetic acid, DMSO and THF. In addition, it will be disintegrated by nucleophilic substances like ammonia (such as ammonium salts under alkaline conditions) or acetate.

Ethylene-tetrafluorethylene copolymer (ETFC, Tefzel®)

This fluorinated polymer is highly resistant against neutral and alkaline solvents. Some chlorinated chemicals in connection with this material should be handled with care. Maximum operating Temperature is 80 °C.

Perfluorethylenpropylen-Copolymer (FEP), Perfluoralkoxy-Polymer (PFA)

These fluorinated polymers hold similar features as PTFE, but with a lower operation temperature (up to 205 °C). PFA is suitable for ultrapure applications, FEP can be used universally. They are resistant against almost all organic and inorganic chemicals, except elemental fluorine under pressure or at high temperatures and fluorine-halogen compounds.

Polyoxymethylene (POM, POM-H-TF)

POM is a semi-crystalline, high-molecular thermoplastic material which stands out due to its high stiffness, low friction value and thermic stability. It can even substitute metal in many cases. POM-H-TF is a combination of PTFE fibres and acetal resin and is softer and has better slip properties as POM. The material is resistant against diluted acids (pH > 4) as well as diluted lyes, aliphatic, aromatic and halogenated hydrocarbons, oils and alcohols. It is not compatible with concentrated acids, hydrofluoric acid and oxidizing agent. Maximum operating Temperature is 100 °C.

Polyphenylene sulfide (PPS)

PPS is a soft polymer which is known for its high break resistance and very high chemical compatibility. It can be used with most organic, pH neutral to pH high, and aqueous solvents at room temperature without concerns. However, it is not recommended for using with chlorinated, oxidizing and reducing solvents, inorganic acids or at higher temperatures. Maximum operating temperature: 50 °C.

Polytetrafluorethylene (PTFE, Teflon®)

PTFE is very soft and anti-adhesive. This material is resistant against almost all acids, lyes and solvents, except against fluid sodium and fluoride compounds. In addition, it is temperature-resistant from -200 °C to +260 °C.

Systec AF™

This amorphous perfluorinated copolymer is inert against all commonly used solvents. However, it is soluble in perfluorinated solvents like Fluorinert® FC-75 and FC-40, and Fomblin perfluor-polyether solvents from Ausimont. In addition, it is affected by Freon® solvents.

Polychlorotrifluorethylene (PCTFE, Kel-F®)

The semi-crystalline thermoplastic material is plasticizer-free and dimensionally stable, even in a wide temperature range (-240 °C to +205 °C).

It is moderately resistant against ether, halogenated solvents and toluene. Halogenated solvents over +60 °C and chlorine gas should not be used.

Fluorinated rubber (FKM)

The elastomer consisting of fluorinated hydrocarbon stands out due to a high resistance against mineral oils, synthetic hydraulic fluids, fuels, aromatics, and many organic solvents and chemicals. However, it is not compatible with strong alkaline solvents (pH value >13) like ammonia, and acidic solvents (pH value <1), pyrrole and THF. Operating temperature: Between -40 °C and +200 °C.

Perfluorinated rubber (FFKM)

This perfluoro elastomer has a higher fluorine content as fluorinated rubber and is therefore chemically more resistant. It can be employed at higher temperatures (up to 275 °C). It is not compatible with Pyrrole.

13.3 Non-metals

Diamond-like carbon (DLC)

This material is characterized by a high hardness, a low coefficient of friction and thus low wear. In addition, it is highly biocompatible. DLC is inert against all acids, alkalis and solvents commonly used in HPLC.

Ceramic

Ceramic is resistant against corrosion and wear and is fully biocompatible. An incompatibility against acids, alkalis and solvents commonly used in HPLC is not known.

Alumina (Al₂O₃)

Due to their high resistance to wear and corrosion, alumina ceramic is used as a coating for mechanically stressed surfaces. It is a biocompatible material with low thermal conductivity and low thermal expansion.

Zirconium oxide (ZrO₂)

Zirconia ceramics are characterized by their high mechanical resistance, which makes them particularly resistant to wear and corrosion. It is also biocompatible, has low thermal conductivity and is resistant to high pressures.

Sapphire

Synthetic sapphire is virtually pure monocrystalline alumina. It is biocompatible and very resistant to corrosion and wear. The material is characterized by a high hardness and a high thermal conductivity.

Ruby

Synthetic ruby is monocrystalline alumina and gets its red color by the addition of some chromium oxide. It is biocompatible and very resistant to corrosion and wear. The material is characterized by a high hardness and a high thermal conductivity.

Mineral wool

This insulating material consists of glass or stone wool fibres and isolates in high oxidizing conditions and at high temperatures. Mineral wool is valid as commonly inert against organic solvents and acids.

Glass, glass fibre, quartz, quartz glass

These mineral materials are resistant against corrosion and wear and are mostly chemical inert. They are compatible with oils, fats and solvents and show a high resistance against acids and lyes up to pH values of 3 - 9. Concentrated acids (especially hydrofluoric acid) may embrittle and corrode the minerals. Lyes may ablate the surfaces slowly.

13.4 Metals**Stainless steel**

Stainless steel is, apart from PEEK, the standard material in HPLC. Steels with WNr. 1.4404 (316L) are used, or with a mixture of higher compatibility.

They are inert against almost all solvents. Exceptions are biological applications which are metal ion sensible, and applications with extreme corrosive conditions. These steels, in comparison to commonly used steels, are increasingly resistant against hydrochloric acid, cyanides and other halogen acids, chlorides and chlorinated solvents.

The use in ion chromatography is not recommended. In case of electrochemical applications, a passivation must be executed first.

Hastelloy®-C

This nickel-chrome-molybdenum alloy is extremely resistant to corrosion, especially against oxidizing, reducing and mixed solvents, even at high temperatures. This alloy may be used in combination with chlor, formic acid, acetic acid and saline solutions.

Titanium, titanium alloy (TiAl6V4)

Titanium has a low weight and a high hardness and stability. It stands out due to its very high chemical compatibility and biocompatibility. Titan is applied when neither stainless steel nor PEEK are usable.

14. Index

A

Ambient conditions 12, 46
 Air humidity 46
Analog control 27
Analog input 46
Analog output 46
Analytical flow cell 40
AVV-marking 44

C

Capillaries
 connecting 17
 leakage 5
 used 6
Chemical compatibility 51
Chromatography software 28
Cleaning
 device 38
 flow cell 39
Communication 45
Company network 20
Connector assignment 25
Control 45

D

Data rate 45
Declaration of conformity 2
Decontamination report 7
Decontamination Report 43
Detection channels 45
Detector 8
Detector type 45
Dimensions 46
Disposal 44
Drift 45

E

Error message 10

F

Features 8
Fiber optics
 replacing 42
Firmware Wizard
 Setting IP addresses 21-22
Flow cell 8
 cleaning 39
 inserting 15
 replacing 38
Flushing solution 43
Foreseeable misuse 3

G

GLP 45

I

Initial startup 12
Inputs 45
Installation 12
Installation Qualification (IQ) 31
Integration time 45
Integrator connector 27
Intended use 3
Interfaces 45
IP address
 setting 21-24

L

Lamp 4, 37
LAN
 connecting 18-20
 Troubleshooting 32
Leakage
 avoiding 5
 management 14
Leak sensor 46
LED panel 10
Legal information 2
Liability limitation 2
Light source 45
Linearity 45

M

Maintenance 6, 37
 contract 37
 tasks 37
Mobile Control 29
 Setting IP addresses 21-23

N

Noise 45

O

Old devices 44
Operating ranges 3
Operation 29
Operation Qualification (OQ) 31
Operation site 12
Operator responsibility 4
Optical path length
 setting 16
Original packaging 43
Outputs 46

P

Pin header 27
Power input 46
Power supply 13
Preparative flow cell 41
 setting optical path length 16

Product information 8

R

Remote control 25

Reorders 47

Resetting 10

Router 19

S

Safety

 features 4

 instructions 3

 Personal safety equipment 4

Scope of delivery 8

Service request form 6, 43

Signal words 1

Software control 29

solvents 5

Solvents

 chemical compatibility 51

 disposal 44

 health-threatening 5

Space requirement 13

Specific environments 6

Spectral bandwidth 45

Standby 10

Storage 43

Switching on 28

Symbols and signs 11

System messages 34

T

Taking out of operation 43

Technical data 45

Temperature 46

 ambient 12

Time constraints 45

Transport 43

 damage 2

Troubleshooting 32

U

Unpacking 12

User qualification 3

V

Views 9

W

Warranty conditions 2

Warranty seal 2

Wavelength

 setting 30



Wavelength accuracy 45

Wavelength precision 45

Wavelength range 45

WEEE Registration Number 44

Weight 46

	Created	Reviewed	Approved
Function	Technical Editor	Engineering	Head of Quality
Name	Anna Erben	Paul Pietsch	Kate Monk
Date	23/02/2023	23/02/2023	23/02/2023
Signature			 <small>Kathryn Monks (Paul, 2023 15:21 GMT+1)</small>

0. Customer approval

Prior to installation at the customer site, the customer has reviewed the OQ document and agrees with the design and scope.

Company name:

Name	Function	Reviewed & approved	Date	Signature

1. Definition of the Installation Qualification

The qualification document „Installation Qualification (IQ)“ is part of the quality management system at the company KNAUER Wissenschaftliche Geräte GmbH.

2. Scope

The customer can request the Installation Qualification. In case of a request, the technical support of KNAUER or a provider authorized by KNAUER performs this functionality test during the installation. The IQ is a standardized document and includes the following:

- Confirmation of flawless condition at delivery
- Check if the delivery is complete
- Certification on the functionality of the device

3. Instructions

All deviations from the specifications that occurred during installation have to be recorded in this document.

In addition, all measures taken to eliminate the deviations have to be noted down as comments in the list of rectifications (LOR) on page 4.

If certain items in the report are not applicable, this has to be indicated in the table as „N/A“ (not applicable). Major sections that are not used have to be crossed out (diagonal line), marked „N/A“, dated and signed.

All required documents have to be completed by the end of the installation. The document has to be reviewed and approved by an authorized person. The review and approval have to be documented with signature and date (DD/MM/YYYY).

The tests have to be carried out in a suitable environment, as described in the user instruction of the device.

4. About this document

The information in this document is subject to change without prior notice. This document may not be used, reproduced or translated without written consent of KNAUER Wissenschaftliche Geräte GmbH. Depending on the customer's quality assurance system, the signed document either has to be filed in the device folder or scanned and stored in an electronic archive.

5. Device data

Device name		Product number	
Serial number		Order number	
Firmware version			
Installation location			

6. Customer and manufacturer data

	Customer	Manufacturer
Company		KNAUER Wissenschaftliche Geräte GmbH
Customer number		-
Contact person/agent		
Address		Hegauer Weg 38
Postal Code/City		14163 Berlin
Phone		+49 30 80 97 27 111
E-Mail		support@knauer.net

7. Installation Qualification Tests

Test	Description	Specification	Passed	Failed	N/A	Comment/LOR No.
1	Identify the device.	The name on the device matches the name on the delivery order.				
2	Check the device for transport damage.	No transport damage is observed.				
3	Check the scope of delivery.	The scope of delivery matches the packing list and/or the delivery order.				
4	Check that the technical documentation provided is correct and complete (material documentation of wetted parts, calibration certificates etc.)	The documentation is correct and complete.				
5	Check that all equipment is properly and correctly labeled according to the delivery order and/or the labeling specifications document, if applicable.	The equipment is labeled correctly.				
6	Connect all loose parts (e.g. capillaries, tubings, measuring head) according to the user instructions.	The device is fully assembled and ready to use.				
7	Ensure that the installation site is suitable according to the user instructions.	The installation site matches the specifications in the user instructions.				
8	Connect the device to the power supply and switch it on.	The device starts (operating noise). The power LED or the display lights up.				

8. List of rectifications (LOR)

LOR No.	Test No.	Type of deviation*	Description of the deviation	Action plan	Persons responsible	Due date	Date/signature

*Type of deviation:

A = acceptable (e.g. not a GMP-critical deviation)

N = not acceptable

Continuation of qualification activities into the next qualification phase is only possible when deviation is rectified.

T = temporarily acceptable

a) Release and use of the system is possible, even when the deviation is not rectified.

b) A continuation of qualification activities into the next qualification phase is possible, even when the deviation is not rectified

9. List of changes to the document

Revision no.	Description of change	Additional information	Date/signature

Installation Qualification (IQ) for a Device

10. Certificate and approval

A KNAUER employee or an employee authorized by KNAUER has checked the device and performed all tests described in the IQ.

The IQ form has to be signed by an authorized person. The scope of the IQ meets the customer's requirements.

The results of the IQ, any changes made as well as the IQ process have been documented in this form in writing. The users listed below were instructed and are familiar with how to operate the device. Both parties confirm that the IQ has been performed to the customer's satisfaction by signing it.

10.1 Customer approval

Name	Function	Date	Signature

10.2 KNAUER agent approval

Name	Function	Date	Signature

11. Comments / recommendations

Science with Passion



Latest KNAUER instructions online:
www.knauer.net/library

KNAUER
Wissenschaftliche Geräte GmbH
Hegauer Weg 38
14163 Berlin

Phone: +49 30 809727-0
Fax: +49 30 8015010
E-mail: info@knauer.net
Internet: www.knauer.net