

AzurA

Pump P 2.1S/P 4.1S Instructions



HPLC



Note: For your own safety, read the instructions and follow the warnings and safety information on the device and in the instructions. Keep the instructions for future reference.



Note: In case you require this instruction in another language, please submit your request including the corresponding document number via e-mail or fax to KNAUER.

Support: Do you have questions about the installation or the operation of your instrument or software?

International Support:

Contact your local KNAUER partner for support:

www.knauer.net/en/Support/Distributors-worldwide

Support in Germany

(Austria & Switzerland on case-to-case basis):

Phone: +49 30 809727-111 (workdays 9-17h CET)

Fax : +49 30 8015010

E-mail: support@knauer.net

Publisher: KNAUER Wissenschaftliche Geräte GmbH

Hegauer Weg 38

14163 Berlin

Germany

Phone: +49 30 809727-0

Fax: +49 30 8015010

Internet: www.knauer.net

E-mail: info@knauer.net

Version information: Document number: V6870

Version number: 5.8

Release date: December 2, 2022

Translation of the original edition

This instruction applies to products with the product number: EPGXXYYZZ

The information in this document is subject to change without prior notice. For the latest version of the instructions, visit our website: www.knauer.net/library



Copyright: This document contains confidential information and may not be reproduced without written consent of KNAUER Wissenschaftliche Geräte GmbH.

© KNAUER Wissenschaftliche Geräte GmbH 2022
All rights reserved.

AZURA® is a registered trademark of
KNAUER Wissenschaftliche Geräte GmbH.

Table of contents

1. Product information	1
1.1 Device overview	1
1.2 Intended use	1
1.3 Views	1
1.3.1 Front view	1
1.3.2 Rear view	1
1.4 Features	2
1.4.1 Performance overview	2
1.4.2 Options	2
1.5 Pump heads	2
2. Scope of delivery	3
3. Basic safety instructions	3
3.1 Target group	3
3.2 Safety equipment	4
3.3 What does the user have to consider?	4
3.4 Where is use of the device prohibited?	5
3.5 Taking the device safely out of operation	5
3.6 Opening the device	5
3.7 Warnings	5
3.8 Decontamination	5
4. Symbols and signs	6
5. Unpacking and setup	7
5.1 Preparations	7
5.1.1 Location requirements	7
5.2 Power supply	7
5.2.1 Conditions	7
5.2.2 Power plug	8
5.3 Unpacking the device	8
5.3.1 Removing transport protection	8
5.4 Integrating the pump into the HPLC system	9
5.5 Connecting the eluent line to the pump head	10
5.6 Ports on the rear side	11
5.6.1 Pin header connectors	11
5.6.2 Connecting cables to the pin header	12
5.6.3 Ground	12
5.7 Connecting the device to a computer	13
5.7.1 Configuring the LAN settings	13
5.7.2 Connect devices to the LAN	13
5.7.3 Configuring the router	14
5.7.4 Integrating the LAN into the company network	14

5.7.5	Controlling several systems separately in the LAN	15
5.7.6	Firmware Wizard:	15
5.7.6.1	Firmware Wizard: Assign static IP address	15
5.7.6.2	Firmware Wizard: Assign dynamic IP address	16
5.7.6.3	APIPA	16
6.	Initial startup	17
6.1	Switching on the pump	17
6.2	Operation	18
6.2.1	Controlling via keyboard at the device	18
6.2.2	Menu Structure	19
6.2.2.1	Setting the Flow Rate	19
6.2.2.2	Adjusting pressure turn-off (only P 4.1S)	20
6.2.2.3	Setting the shutdown threshold	21
6.2.2.4	Piston seal wash	21
6.2.3	Choosing pump head	22
6.2.4	Flushing the pump	22
6.2.5	Software	23
6.2.5.1	Via Local Area Network (LAN)	23
6.2.5.2	Via RS-232 port	23
6.2.5.3	Control commands	23
6.2.5.4	Activating the analog control (prior to firmware version 1.37)	25
6.2.5.5	Adjusting the analog control (prior to firmware version 1.37)	25
6.2.5.6	Controlling the flow rate analog	26
6.2.5.7	Starting with a short-circuit	26
6.2.5.8	Starting directly after connection to power supply	26
6.3	Switching off the pump	27
7.	Functionality tests	28
7.1	Installation Qualification (IQ)	28
7.2	Operation Qualification (OQ)	28
8.	Troubleshooting	29
8.1	LAN	29
8.2	Possible problems and solutions	30
9.	Maintenance and care	31
9.1	Maintenance contract	31
9.2	Cleaning and caring for the device	31
9.3	Which type of maintenance tasks may users perform on the device?	31
9.3.1	Pump head	31
9.3.1.1	Torque values	31
9.3.1.2	Removing the pump head	32
9.3.1.3	Installing the pump head	32
9.3.2	Check valves	33
9.3.3	Removing the check valves	33
9.3.4	Cleaning the check valves	33
9.3.5	Installing the check valves	34

10. Technical data	35
10.1 General	35
10.2 Communication	35
10.3 Technical parameters	36
10.4 Dimensions	36
11. Chemical compatibility of wetted materials	37
11.1 General	37
11.2 Plastics	37
11.2.1 Polyetheretherketone (PEEK)	37
11.2.2 Polyethylene terephthalate (PET, outdated PETP)	37
11.2.3 Polyimide (Vespel®)	38
11.2.4 Ethylene-tetrafluorethylene copolymer (ETFC, Tefzel®)	38
11.2.5 Perfluorethylenpropylen-Copolymer (FEP), Perfluoralkoxy-Polymer (PFA)	38
11.2.6 Polyoxymethylene (POM, POM-H-TF)	38
11.2.7 Polyphenylene sulfide (PPS)	38
11.2.8 Polytetrafluorethylene (PTFE, Teflon®)	38
11.2.9 Systec AF™	38
11.2.10 Polychlortrifluorethylene (PCTFE, Kel-F®)	38
11.2.11 Fluorinated rubber (FKM)	39
11.2.12 Perfluorinated rubber (FFKM)	39
11.3 Non-metals	39
11.3.1 Diamond-like carbon (DLC)	39
11.3.2 Ceramic	39
11.3.3 Alumina (Al ₂ O ₃)	39
11.3.4 Zirconium oxide (ZrO ₂)	39
11.3.5 Sapphire	39
11.3.6 Ruby	39
11.3.7 Mineral wool	39
11.3.8 Glass, glass fibre, quartz, quartz glass	40
11.4 Metals	40
11.4.1 Stainless steel	40
11.4.2 Hastelloy®-C	40
11.4.3 Titanium, titanium alloy (TiA16V4)	40
12. Repeat orders	41
12.1 Accessories	41
12.2 Device variants	42
12.3 Available pump heads	43
13. Legal information	44
13.1 Transport damage	44
13.2 Warranty conditions	44
13.3 Declaration of conformity	44
14. Disposal	45
14.1 AVV-Marking Germany	45
14.2 WEEE-Registration number	45
14.3 Eluents and other operating materials	45

1. Product information

1.1 Device overview

The HPLC pumps P 4.1S/ P 2.1S with pump heads can be used as feed pumps or dosing pumps in analytical or preparative applications. Pumps transport solvents or dissolved samples through the HPLC system.

1.2 Intended use



Note: Only use the device for applications that fall within the range of the intended use. Otherwise, the protective and safety equipment of the device could fail.

Operating ranges The device can be used in the following areas:

- Biochemical analyses
- Food analysis
- Pharmaceutical analysis
- Environmental analysis
- Chemical analysis
- Dosing applications

1.3 Views

1.3.1 Front view

Legend

- ① Display
- ② Keypad
- ③ Pump Head
- ④ Pressure sensor

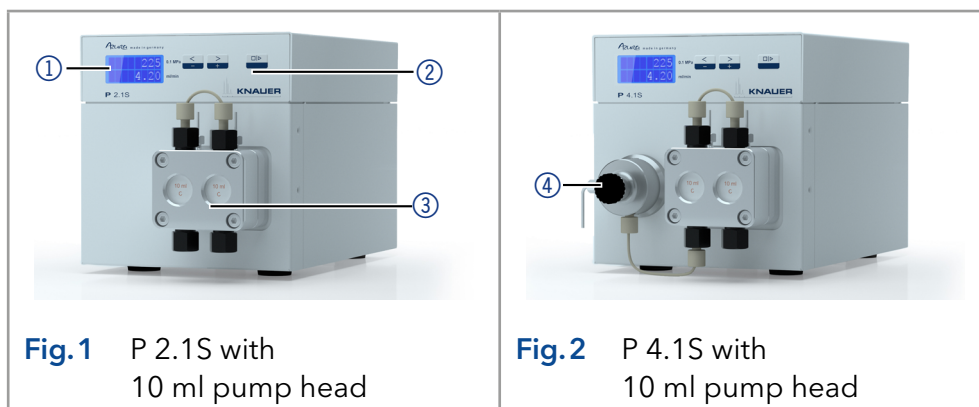

Fig.1 P 2.1S with 10 ml pump head

Fig.2 P 4.1S with 10 ml pump head

1.3.2 Rear view

Legend

- ① Fan
- ② UKCA mark
- ③ CE mark
- ④ Serial number
- ⑤ Interface RS-232
- ⑥ LAN connection
- ⑦ Pin header for remote control
- ⑧ Power connection - bushing
- ⑨ Hole for the ground connection

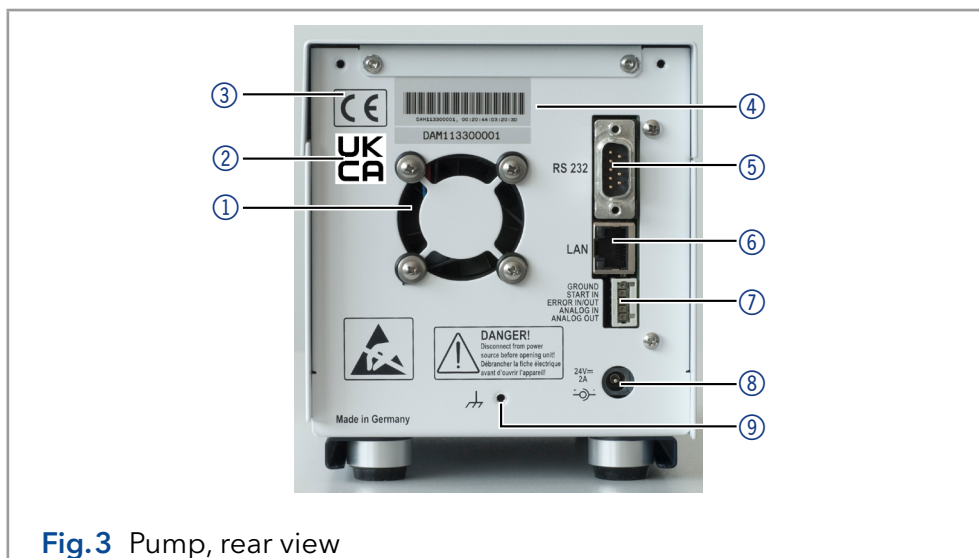

Fig.3 Pump, rear view

1.4 Features

- Analytical pump head with a flow rate range from 0.001 – 9.999 ml/min and a pressure of up to 400 bar
- Analytical pump head with a flow rate range from 0.01 – 50 ml/min and a pressure of up to 150 bar
- Dual-piston technology for constant flow rates
- Setting a limit for minimum and maximum pressure to protect the HPLC columns and to avoid a dry run of the pump (only P 4.1S)
- Emergency stop, independent from control with chromatography software
- The pump can be controlled with the keypad in standalone mode or with the chromatography software.
- The pump heads can be easily removed and replaced via four front-accessible screws by the user.
- Unlike the pump P 2.1S, pump P 4.1S is equipped with a pressure sensor.

1.4.1 Performance overview

- Liquid transport with stable flow rate and high flow accuracy
- Long service life
- Pump head made of stainless steel or with Hastelloy-C or ceramic inlays
- Piston backflushing
- High physical and chemical stability
- Flexible control with LAN connection, RS-232 interface, and analog control signals
- Control with chromatography software

1.4.2 Options

A pump in combination with another pump can be used optionally to set up a binary high pressure gradient system.

1.5 Pump heads

Pump head for use in analytical applications:

- Stainless steel with stainless steel inlays for standard applications
- Stainless steel with stainless steel inlays and sapphire pistons for water applications
- Stainless steel with ceramic inlays for biocompatible applications
- Stainless steel with Hastelloy-C inlays for corrosive media
- Different pump head sizes: 10 ml or 50 ml

The front of the pump head is labeled with the maximum pumping capacity (10 ml or 50 ml). Pump heads with inlays are additionally labeled with the respective material (SST for stainless steel, Ti for titanium, C for ceramic, HC for Hastelloy-C).

Legend

- ① Flow rate
- ② Material

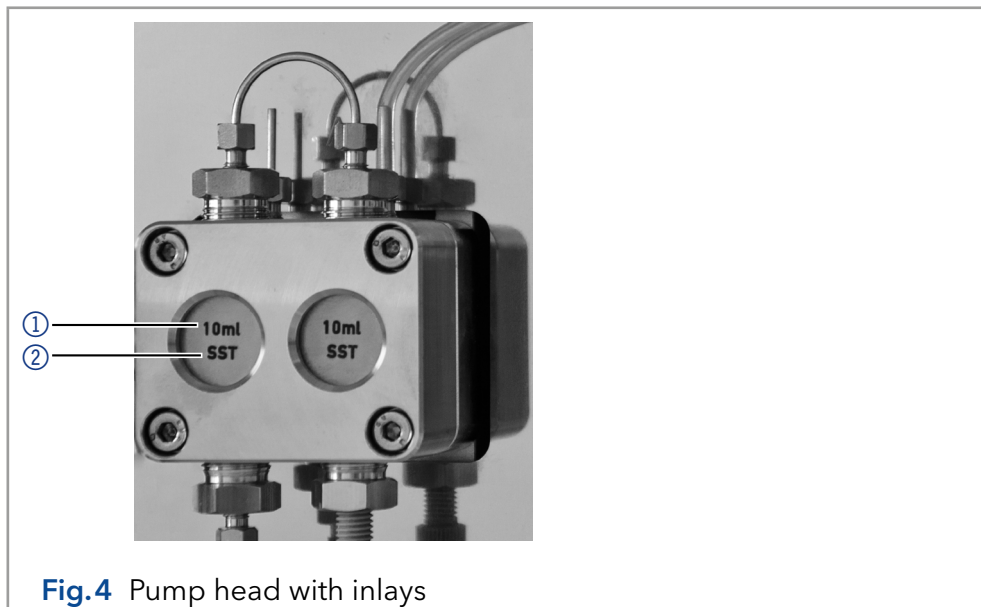

2. Scope of delivery



Note: Only use spare parts and accessories made by KNAUER or a company authorized by KNAUER.

- 24 V power adapter with power cable
- Instructions (German/English)
- AZURA accessories kit
- P 2.1S/P 4.1S accessories kit
- Declaration of conformity

3. Basic safety instructions

3.1 Target group

The document is intended for people who have completed at least a training as a chemical laboratory assistant or a comparable training path.

The following knowledge is required:

- Fundamental knowledge of liquid chromatography
- Knowledge regarding substances that are suitable only to a limited extent for use in liquid chromatography
- Knowledge regarding the health risks of chemicals
- Participation during an installation of a device or a training by the company KNAUER or an authorized company.

If you do not belong to this or a comparable professional group, you must under no circumstances carry out the work described in this operating manual. In this case, please contact your superior.

3.2 Safety equipment

When working with the device, take measures according to lab regulations and wear protective clothing:

- Safety glasses with side protection
- Protective gloves
- Lab coat

3.3 What does the user have to consider?

- All safety instructions.
- The environmental, installation and connection specifications
- When working with solvents, make sure the room is well-ventilated.
- National and international regulations pertaining to laboratory work
- Original spare parts, tools, and eluents made or recommended by KNAUER
- Good Laboratory Practice (GLP)
- Accident prevention regulations of the accident health insurance companies for laboratory activities.
- Filtration of substances under analysis
- Use of inline filters
- No used capillaries elsewhere in the chromatographic insert system
- Only use a given PEEK fitting for one specific port and never re-use it for other ports. Always install new PEEK fittings on each separate port.
- Follow KNAUER or manufacturer's instructions on caring for the columns

Other important topics for your security are listed alphabetically in the following list:

- **Flammability:** Organic eluents are highly flammable. Since capillaries can detach from their screw fittings and allow eluent to escape, it is prohibited to have any open flames near the analytical system.
- **Solvent tray:** Risk of electrical shock or short circuit if liquids get into the device's interior. Therefore always use a bottle tray.
- **Eluent lines:** Install capillaries and hoses in such a way that liquids cannot get into the interior in case of a leak.
- **Leaks:** Regularly check if any system components are leaking.
- **Auto-ignition:** Only use eluents that have an auto-ignition temperature of more than 150 °C under normal room condition.
- **Power strip:** If several devices are connected to one power strip, always consider the maximum power consumption of each device.
- **Power supply:** Only connect devices to voltage sources, whose voltage equals the device's voltage.
- **Toxicity:** Organic eluents are toxic above a certain concentration. Ensure that work areas are always well-ventilated! Wear protective gloves and safety glasses when working on the device!
- **Supply cable:** Damaged supply cables must not be used to connect the devices to the power supply.

3.4 Where is use of the device prohibited?

Never use the system in potentially explosive atmospheres without appropriate protective equipment. For more information, contact KNAUER Technical Customer Support.

3.5 Taking the device safely out of operation

The device can be taken out of operation completely at any time by turning off the power switch of the power supply or disconnecting the supply connection.

3.6 Opening the device

Only have the device opened by a KNAUER Technical Customer Service representative or a KNAUER authorized company.

3.7 Warnings

Possible dangers that can arise from a device are classified into personal injury or damage to property.



DANGER (red) indicates a high degree of risk. If not followed, will result in death or serious injury.



WARNING (orange) indicates the average degree of risk. Failure to do so may result in death or serious injury.



CAUTION (yellow) indicates a low risk level of the hazard. Failure to do so may result in minor or moderate injury.



NOTICE (blue) indicates features that are not related to injury.

3.8 Decontamination

Contamination of devices with toxic, infectious or radioactive substances poses a hazard for all persons during operation, repair, sale, and disposal of a device.



Life-threatening injuries

Health danger if getting in contact with toxic, infectious or radio-active substances.

→ Before disposing of the device or sending it away for repair, you are required to decontaminate the device in a technically correct manner.

All contaminated devices have to be properly decontaminated by a specialist company or the operating company before they can be recommissioned, repaired, sold, or disposed of. All materials or fluids used for decontamination have to be collected separately and disposed of properly.







Decontamination report

Devices that reach KNAUER without a service request form (decontamination report) will not be repaired. If you return a device to KNAUER, you must enclose the completed service request form:

www.knauer.net/Dokumente/service/VFM-SBS-EN.pdf.

4. Symbols and signs

The following table explains symbols and labels which are used on the device or in the instruction:

Symbol	Meaning
	The device complies with the product-specific requirements of the European Union.
	The device complies with the product-specific requirements of the United Kingdom.
	High-voltage hazard
	Electrostatic-discharge hazard
	Testing seals in Canada and the USA at nationally recognized testing centers (NRTL). The certified device or system has successfully passed the quality and security tests.
	Notes provide useful tips and valuable information.

5. Unpacking and setup

5.1 Preparations

5.1.1 Location requirements



Note: The intended use be ensured only if the requirements for ambient conditions of the operating environment are met. You will find the ambient conditions in chapter "Technical data" on page 35.

NOTICE

Device defect

The device overheats at exposure to sunlight and insufficient air circulation. Device failures are very likely.

- Set up the device in such a way that it is protected against exposure to direct sunlight.
- Leave room for air circulation: See paragraph „space requirements“.

General requirements

- Position the device on a level surface.
- Protect the device against direct exposure to sunlight.
- Set up the device at a location not exposed to air drafts such as air conditioning systems.
- Protect the device from strong draft.
- Do not set up the device near to machines that cause floor vibrations.
- Keep the the devices away from high frequency sources. High-frequency sources may compromise measuring values.

Space requirements

- At least 5 cm, if there is another device on one side.
- At least 10 cm, if there are devices set up on both sides.
- At least 15 cm to the cooler fan on the rear.

5.2 Power supply

NOTICE

Electronic defect

Electronic hazard when using an identically constructed power adapter from another manufacturer.

- Only use spare parts and accessories from KNAUER or a company authorized by KNAUER.

For power supply, use the supplied power cable and power adapter to meet the specifications which are described in the chapter Technical Data. But inspect the provided power cable beforehand to ensure that it is approved for your country. Replace defective power cables only with accessories from KNAUER. Detachable power cables are not allowed to be replaced with other cable types.

5.2.1 Conditions

- The electrical power supply at the installation site has to be connected directly to the nearest main power line.
- The power has to be free from ripple, residual current, voltage peaks and electromagnetic interference.

- The connectors for the mains voltage are grounded accordingly.
- The device receives sufficient power with reserve capacity

5.2.2 Power plug

- The power adapter is intended for use with AC power networks of 100 - 240 V.
- Make sure that the power plug on the rear of the device is always accessible, so that the device can be disconnected from the supply.



Note: The nominal capacity of the connected devices has to be maximum 50 % of the power supply to account for larger inrush currents when switching on the modules.

5.3 Unpacking the device

Prerequisites

- Check the carton for damage caused during transportation.

Tools

- Utility knife

CAUTION

Bruising danger

Damage to the device by carrying or lifting it on protruding housing parts. The device may fall and thus cause injuries.

→ Lift the device only centrally on the side of the housing.

Process

1. Set-up the package in such a way that you can read the label.
2. Using the utility knife, cut the adhesive tape and open the packaging.
3. Lift the foam padding. Take out the accessories kit and the manual.
4. Open the accessories kit and check the scope of delivery. In case any parts are missing, contact the Technical Support.
5. Clasp the device from below, lift it out of the packaging and place it on its feet. Do not hold onto the front cover.
6. Check the device for signs of damage that occurred during transport. In case any parts are missing, contact the Technical Support.
7. Set up the device at the operation site. Lift the foam padding.

Next steps

Store packaging and keep the included packing list for repeat orders.

5.3.1 Removing transport protection

Foam parts are inserted between the ends of the pump capillaries and the housing  as transport protection to prevent damages of the paintwork during transportation. After setting up the device, the foam parts can be removed. In case of a new transport or storage, the foam parts should be inserted between the capillaries and the device.

Legend

- ① Foam padding

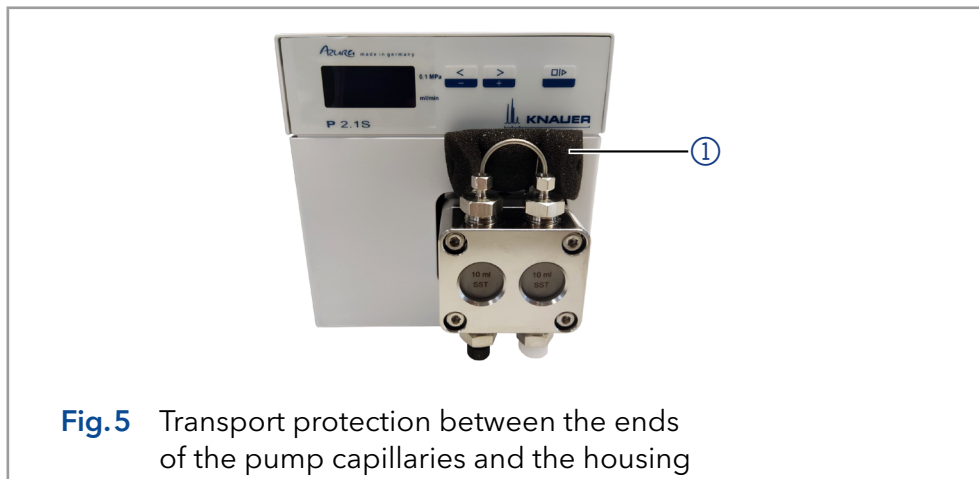

Fig.5 Transport protection between the ends of the pump capillaries and the housing

5.4 Integrating the pump into the HPLC system

The pump can be integrated into an HPLC system by connecting the pressure sensor (P 4.1S) or the pump head outlet (P 2.1S) and the HPLC system with capillaries.



Note: To integrate the pump into a system, note the ambient conditions found in the sections Operating Environment and Technical Data as well as the ambient conditions of other devices to be integrated into that system.

NOTICE

Component defect

Possible damage to the pump head due to over-tightened capillary fitting.

➔ Note the torque of the screw connection.

The figure shows the installation plan for capillary and tubing on both P 2.1S and P 4.1S versions of the pump.

Legend

- Connection solvent to pump
- - - Passive piston backflushing

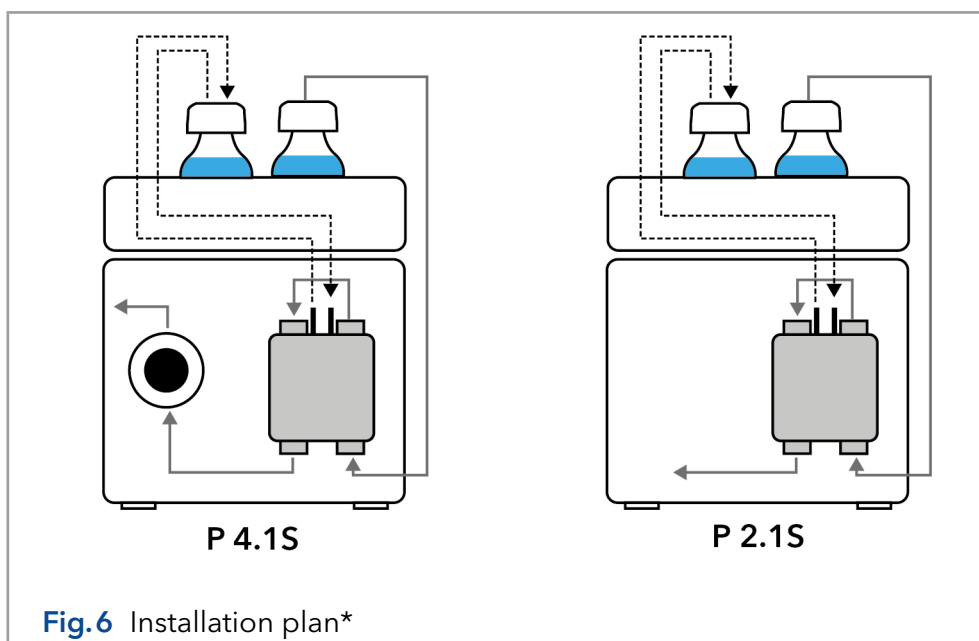

Fig.6 Installation plan*

*This is an exemplary presentation.

Piston backflushing

To flush the backpiston space, aspirate flushing solution with the syringe included in the accessory kit. Ensure regular backpiston flushing for optimal seal lifetime.

Solvent flow path

The pump head takes the liquid in from the solvent bottle and conveys it to the pressure sensor (P 4.1S) or directly into the HPLC system (P 2.1S).

5.5 Connecting the eluent line to the pump head

- Prerequisites**
- The device has been switched off.
 - The power plug has been pulled.

- Tools**
- Flangeless fitting
 - Flat seal



Note: Fittings, hose and filter are supplied in the pump's accessory kit (article no. FPGA).

NOTICE**Device defect**

Damage to pump head, device or system when inlet and outlet of the pump head are blocked.

→ Remove the cap fittings from the inlet and outlet of the pump head prior to use.

Procedure**Process****Figure**

1. Stick the tube ④ through the nut ③.
2. Stick the tube through the seal ring ②. The narrow end must point away from the nut.
3. Stick the cutting ring ① onto the tube.
4. Insert the tubing into the free inlet ⑤ on the bottom of the pump head.
5. Tighten the fitting by hand.

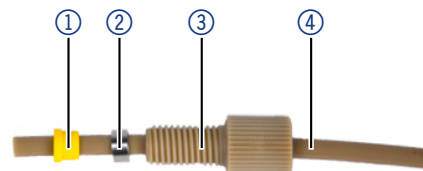

Fig. 7 Tube with nut, seal ring and cutting ring

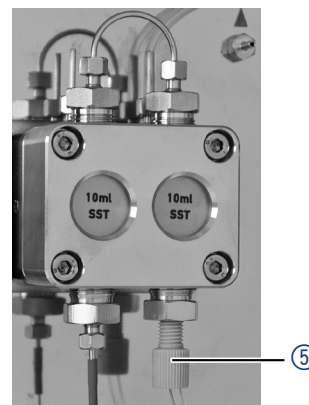

Fig. 8 Solvent line on pump head

- Next steps** Integrate the pump into the HPLC flow system. Use 5 Nm torque for stainless-steel fittings or 1 Nm for PEEK fittings.

5.6 Ports on the rear side

Legend

- ① Fan
- ② UKCA mark
- ③ CE mark
- ④ Serial number
- ⑤ Interface RS-232
- ⑥ LAN connection
- ⑦ Pin header for remote control
- ⑧ Power connection - bushing
- ⑨ Hole for the ground connection

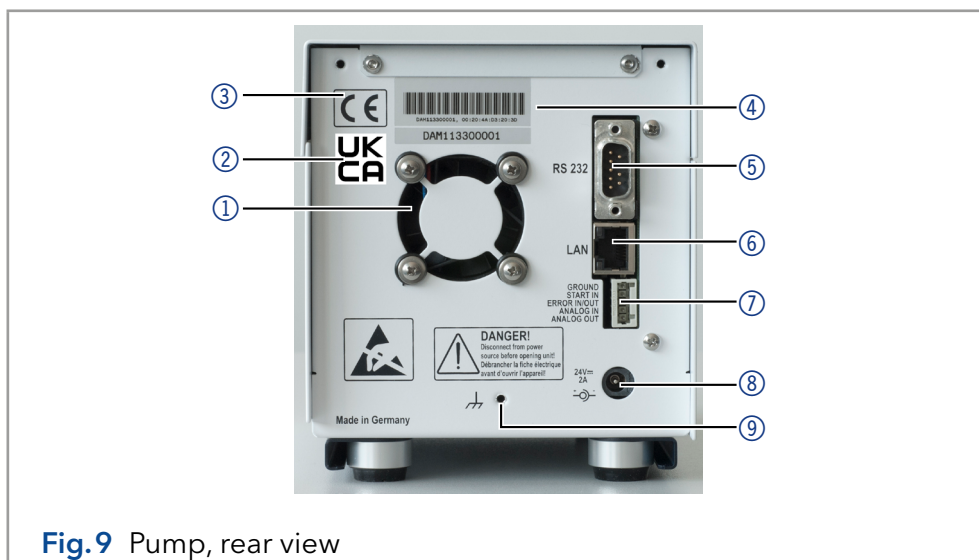

Fig. 9 Pump, rear view

External devices External devices like a computer can be connected to the pump in 3 different ways:

- Via the pin header for remote control ⑥
- Via LAN connector ⑤ within a network
- Connected to RS232 ④, alternately to LAN connection

5.6.1 Pin header connectors

Contact	Explanation
GROUND	Reference point of the voltage at the signal inputs.
START IN	TTL-compatible input <ul style="list-style-type: none"> ▪ Min. 10 mA ▪ Low-active <p>At stand alone, RS-232 or LAN control stops the motor at a short circuit contact between START IN and GROUND.</p> <p>At analog control, the motor starts at a short circuit contact between START IN and GROUND. In addition, pump delivery is automatically started after switching on.</p> <p>This contact can not be used as a trigger to start the data acquisition of a chromatography software.</p>
ERROR IN/OUT	TTL-compatible input <ul style="list-style-type: none"> ▪ min. 10 mA ▪ Low-active <p>This contact can either send an error signal or can receive one. The pump can thus be stopped by the error signal (ERROR-IN) or ensure that a second device is stopped by an error signal that is output at the ERROR-OUT.</p>
ANALOG IN	Flow rate is controlled through external control voltage (0-10 V).
ANALOG OUT	Analog output signal for reproducing the measured system pressure (0-1 V).

5.6.2 Connecting cables to the pin header

To control one device through another, you use the pin header. To use remote control, you have to connect cables to the pin header. The single ports are used to exchange control signals.

Prerequisites

- The device has been switched on.
- The power plug has been pulled.

Tools

- Depressor tool

NOTICE

Electronic defect

Connecting cables to the multi-pin connector of a switched on device causes a short circuit.

- Turn off the device before connecting cables.
- Pull the power plug.

NOTICE

Electronic defect

Electrostatic discharge can destroy the electronics.

- Wear a protective bracelet against electrostatic discharge and ground.

Procedure

1. Insert the depressor tool ③ in an upper small opening at the front of the pin header ①.
2. Insert the cable into the opening ② underneath the inserted depressor tool.
3. Pull out the depressor tool.

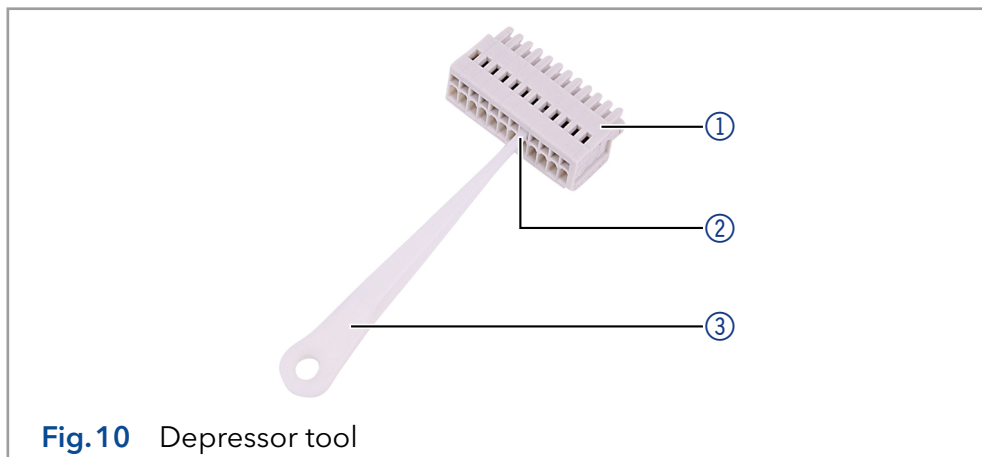

Fig. 10 Depressor tool

Next steps

Check whether the cables are tightly attached. Press the pin header onto the plug. Finish the installation. Afterwards take the device into operation.

5.6.3 Ground

NOTICE

Electronic defect

Electronic hazard when using an identically constructed power adapter from another manufacturer.

- Only use spare parts and accessories from KNAUER or a company authorized by KNAUER.

The ground connection for the pump has a designated hole with a thread M3 on the back of the device.

- If the supplied power adapter is used, then the ground connection remains unused.
- Contact the technical service department of the manufacturer, if the pump along with other devices should be connected to the power supply with a 6-prong power adapter; a pump needs to be grounded exclusively.

5.7 Connecting the device to a computer



Note: HPLC devices from KNAUER only work with IP addresses, which have been assigned by IPv4. IPv6 is not supported.

This chapter describes how to set up a chromatography system in a local area network (LAN) and how a network administrator can integrate this LAN into your company network. The description applies to the operating system Windows® and all conventional routers.

To set up a LAN, we recommend to use a router. That means the following steps are required:

- Process**
1. On the computer, go to the control panel and check the LAN properties.
 2. Hook up the router to the devices and the computer.
 3. Set up the router for the computer network.
 4. Install the chromatography software.
 5. Switch on the device and run the chromatography software.

5.7.1 Configuring the LAN settings

The LAN uses only one server (which is normally the router) from that the devices automatically receive their IP address.

- Prerequisites**
- In Windows®, power saving, hibernation, standby, and screen saver have to be deactivated.
 - In case you use an USB-to-COM box, the option "Allow the computer to turn off this device to save power" in the Device Manager has to be deactivated for all USB hosts.
 - Applies to all LAN devices: Disable the setting for the network adapter in Device Manager: "Allow the computer to turn off this device to save power".

- Procedure**
1. In Windows: Open Network and Sharing Center.
 2. Double-click on **LAN Connection**.
 3. Click on the button **Properties**.
 4. Select **Internet Protocol version 4 (TCP/IPv4)**.
 5. Click on the button **Properties**.
 6. Check the settings in the tab **General**. The correct settings for the DHCP client are:
 - a) Obtain an IP address automatically)
 - b) Obtain DNS server address automatically
 7. Click on the button **OK**.

5.7.2 Connect devices to the LAN

A router ③ has several LAN ports ② and one WAN port ④ that can be used to integrate the LAN into a wide area network (WAN), e.g. a company network or the Internet. In contrast, the LAN ports serve to set up a network from devices ① and a computer ⑤. To avoid interference, we

recommend operating the chromatography system separately from the company network.

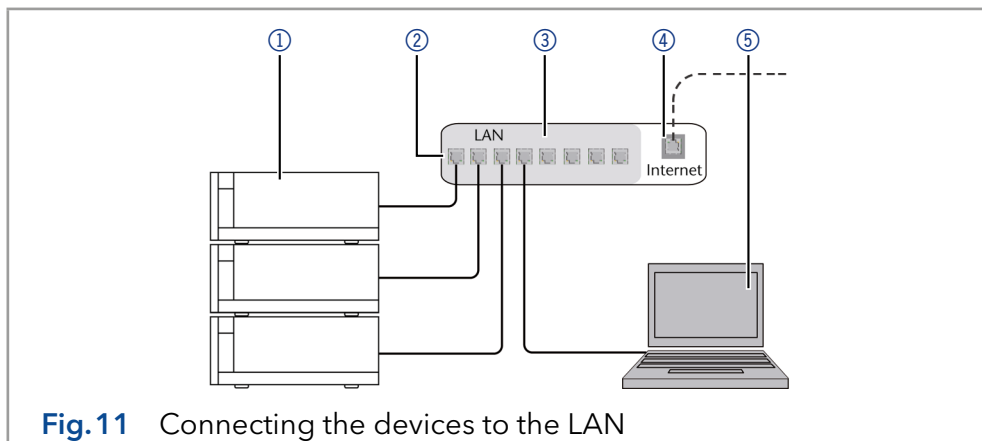

Fig. 11 Connecting the devices to the LAN

You will find patch cables for each device and the router in the accessories kit. To connect the router to a WAN, an additional patch cable is required, which is not supplied within the scope of delivery.

- Prerequisites**
- The computer has been switched off.
 - There is a patch cable for each device and the computer.

- Procedure**
1. Use the patch cable to connect the router and the computer. Repeat this step to connect all devices.
 2. Use the power supply to connect the router to the mains power system.

5.7.3 Configuring the router

The router is preset at the factory. For IP address, user name, and password information, refer to the router instruction: www.knauer.net/en/Support/Library/PC-hardware.

- Procedure**
1. To open the router configuration, start your Internet browser and enter the IP address (not for all routers).
 2. Enter user name and password.
 3. Configure the router as DHCP server.
 4. In the router configuration, check the IP address range and make changes if necessary.



Note: If the IP address range has been changed, it is necessary to note this information down on the router.

Result Once the router has assigned IP addresses to all devices, the chromatography software can be used to remotely control the system.

5.7.4 Integrating the LAN into the company network

A network administrator can integrate the LAN into your company network. In this case you use the WAN port of the router.

- Prerequisites**
- There is a patch cable for the connection.

- Procedure**
1. Check that the IP address range of the router and of the company network do not overlap.
 2. In case of an overlap, change the IP address range of the router.
 3. Use the patch cable to connect the router WAN port to the company network.
 4. Restart all devices, including the computer.

5.7.5 Controlling several systems separately in the LAN

Devices connected to a LAN communicate through ports, which are part of the IP address. If several chromatography systems are connected to the same LAN and are to be controlled separately, you can use different ports to avoid interference. Therefore, the port number for each device has to be changed and the same number has to be entered into the device configuration of the chromatography software. We recommend to use the same port number for all devices in the same system.



Note: The port is set to 10001 at the factory. You must use the same numbers in the device configuration of the chromatography software as in the device, otherwise the connection fails.

1. Find out port number and change it on the device.
2. Enter the port number in the chromatography software.

Result The connection is established.



Note: Assign a fixed IP address.



Note: Check the IT security standards for your lab before you interfere with the LAN settings.

5.7.6 Firmware Wizard:

Changing LAN settings by entering the serial number requires that the device has been found by Firmware Wizard after browsing.

Changing LAN settings by MAC address does not require that the device has been found after browsing. The IP address can be part of another network.

5.7.6.1 Firmware Wizard: Assign static IP address

Prerequisites

- The device has been switched on.
- Firmware Wizard has been installed and started.

Procedure

1. In the Firmware Wizard click on <Reset LAN Settings....>.
2. The <Device connection settings> window opens. In the text box <Target device serial number> ① enter the serial number of the device. The serial number and the MAC address are noted on the back of the device.
3. Choose the option <Use the following IP address> ② .
4. Enter the IP address in the text box <IP address> ③ .
5. If necessary, customize the subnet mask and gateway ④ .
6. Press the button <Reset Conn. Settings> ⑤ to apply the change.
7. Restart the device.

Result The device can now be reached via the static IP address.

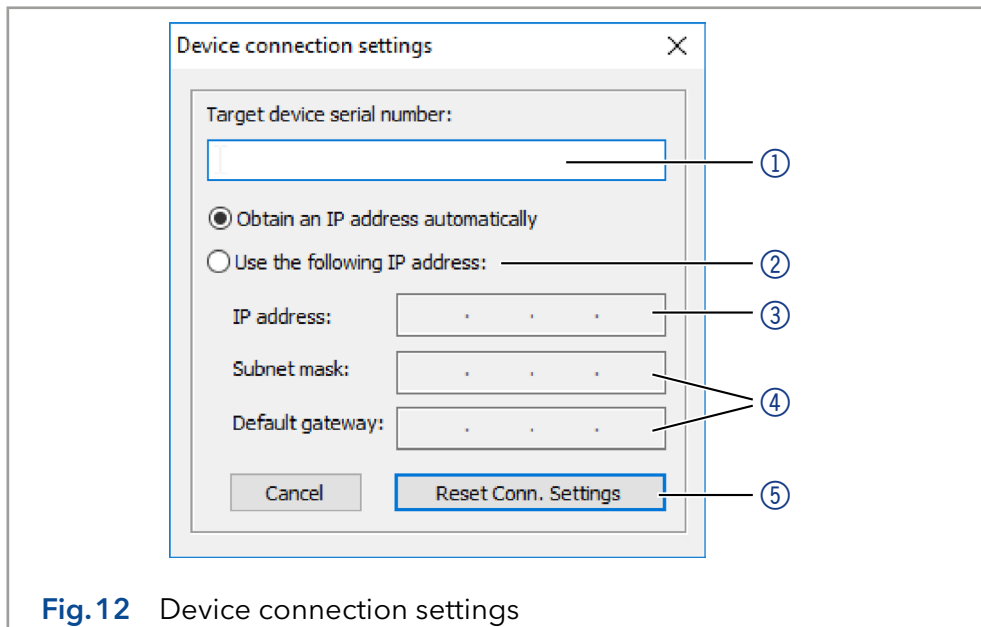

Fig. 12 Device connection settings

5.7.6.2 Firmware Wizard: Assign dynamic IP address

Prerequisites

- The device has been switched on.
- Firmware Wizard has been installed and started.

Procedure

1. In the Firmware Wizard click on <Reset LAN Settings....>.
2. The <Device connection settings> window opens. In the text box <Target device serial number> ① enter the serial number of the device. The serial number and the MAC address are noted on the back of the device.
3. Choose the option <Obtain an IP address automatically>.
4. Press the button <Reset Conn. Settings> ⑤ to apply the change.
5. Restart the device.

Result

The device can now be reached via the static IP address.

5.7.6.3 APIPA

APIPA is a service that allows devices to obtain a dynamic IP address even without a DHCP server in the network. The AZURA Neo platform from KNAUER supports APIPA. The device has to be set to DHCP for this. If no DHCP server responds, the APIPA implementation ensures that the device gives itself a random IP address from the IP address range reserved for APIPA (169.254.x.x). This ensures that 2 devices do not use the same IP address. This process can take several minutes.

At each reboot the device will use a different APIPA IP address. Since Windows also supports APIPA, if the setting for the IP address (IPv4) is set to "Obtain automatically", a connection to the device can be established via this even without a router or fixed IP addresses. It is not recommended to use APIPA in general to establish a connection for device control by chromatography software.

6. Initial startup



Note: It is mandatory to perform a running-in procedure after a pump head maintenance, or if new pump heads are installed on a pump.

If a pump was not in operation for a long time, e.g. after shipment, a running-in procedure might be necessary to obtain the best pump performance. The pump head underwent this procedure during the manufacturing process.

If the pump is performing within specification, or during intensive operation, it is not necessary to perform this procedure.

NOTICE

Component defect

Damage to the pump head in case running-in procedure was not performed correctly.

→ Set the correct backpressure and flowrate for the running-in procedure of the pump head. Specific running-in parameters and the general procedure can be found in the supplement „[Running-in procedure for pump heads \(V6894\)](#)“.

NOTICE

Device defect

If the pump is operated only with pure distilled water, significantly higher wear of the piston and the piston seals can be expected.

→ If possible, only operate the pump with water together with the added additive or modifier.

6.1 Switching on the pump

- Prerequisites**
- At analog control, the contact between GROUND and START IN has to be closed to run the pump.

NOTICE

Component defect

Possible damage to the pump head due to dry running.

→ Make sure that solvent flows through the pump head and piston backflushing.

- Procedure**
1. Connect the power adapter to the power supply.
 2. Connect the pump with plug from the external power adapter.
 3. Switch on the power adapter.
 4. Wait until the pump has completed the self-test.

- Result**
- After the device has been switched on, the display shows pump and the firmware version. The device performs a self-test. After all tests have been successfully completed, the status of the pump with its current flow rate is displayed. The pump is ready for operation.

6.2 Operation

The pump can be operated in three ways:

- Using the keyboard at the device
- Via chromatography software with integrated drivers for the pump
- Analog: Control with applied voltage



Note: Operator errors and clogged capillaries can cause high pressure spikes.

The status display shows the flow rate and also the pressure for pumps with pressure sensor.

Legend



- ① Pressure in 0.1 MPa
- ② Flow rate in ml/min



Fig. 13 Status display

6.2.1 Controlling via keyboard at the device

The keypad consists of 3 buttons, which allow monitoring the device or changing the settings.

Figure	Function
 <p>Fig. 14 Arrow buttons</p>	<ul style="list-style-type: none"> ▪ To scroll through, press both buttons simultaneously. ▪ To change the values in the menu, push the right button when the desired menu item is blinking.
 <p>Fig. 15 Start/Stop key</p>	<ul style="list-style-type: none"> ▪ Switching the pump on or off. ▪ Flushing the Pump

6.2.2 Menu Structure

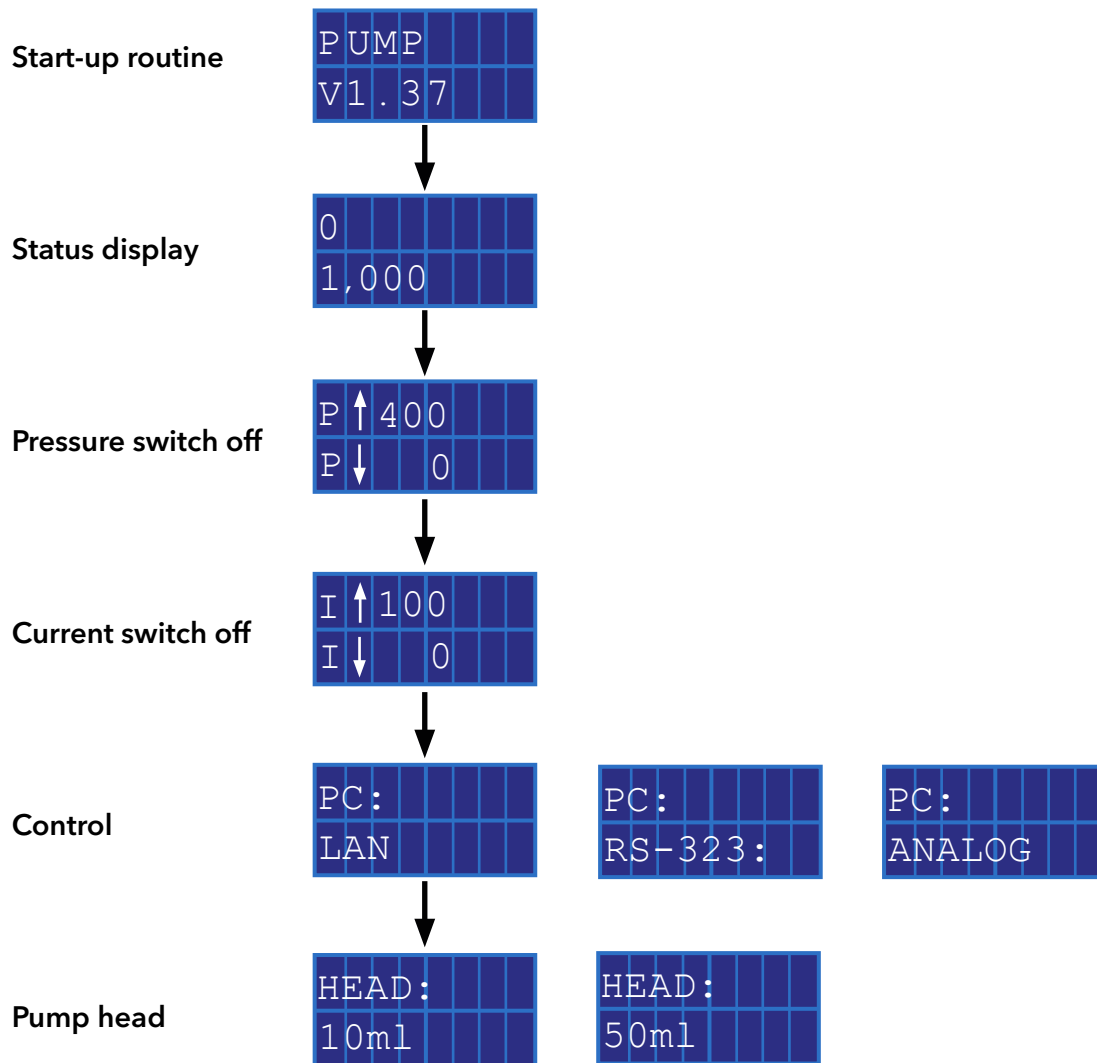

Fig.16 Menu Structure

6.2.2.1 Setting the Flow Rate

In case of the pump without pressure sensor the actual required flow rate is dependent on the resulting counter pressure. The absolute deviation is dependent on the compressibility and the viscosity of the used solvent and on the pump. Therefore, it has to be determined individually for each pump.

The flow rate can be altered while the pump is in operation.



Practical tip: Hold down both arrow keys to expedite changing the values.

NOTICE

Device defect

Danger of strong overpressure: If the button is pressed for a longer time, the flow rate changes much faster.

→ Control the keystroke.

Procedure**Figure**

1. Use the arrow keys to set a value for the flow rate.
2. Check if the right value appears on the display.

**Fig. 17** Display control

- Result**
- The setting is completed and the pump runs at the set flow rate.

6.2.2.2 Adjusting pressure turn-off (only P 4.1S)

- Set maximum pressure to avoid damaging the pump or pump head.
- Set minimum pressure to avoid running the pump dry.

Legend

- ① Maximum value
- ② Minimum value

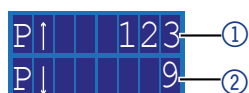
**Note: 18** Setting maximum and minimum pressure

Note: If the minimum is set to 0, the minimum pump pressure is not monitored.



Note: Configuring the pump heads 10 ml or 50 ml, the maximum pressure for the respective pump head is applied.

Procedure**Figure**

1. To scroll through, press both buttons simultaneously.

**Fig. 19** Arrow buttons

2. When the cursor flashes, use the arrow keys again to set the value for the maximum pressure.

**Fig. 20** Maximum pressure

3. Hold down the left arrow key. Press right arrow key once.

4. When the cursor flashes, use the arrow keys again to set the value for the minimum pressure.

**Fig. 21** Minimum pressure

5. Press start/stop key once to return to the start display.

- Result**
- The setting is accepted. If the maximum pressure is exceeded, the pump switches off. If the minimum pressure is undercut, the pump switches off after 30 s. In both cases, an error message is shown on the display, which has to be confirmed at a control via keyboard or analog. In case of control via chromatography software, it may not be necessary.

6.2.2.3 Setting the shutdown threshold

The shutdown threshold is dependent on the flow rate and the counter pressure. It increases with higher flow rates and stronger counter pressure.

- Exceeding or undercutting the values for the maximum or minimum power switch off leads to the pump being automatically shutdown.
- Set the maximum power switch off for the pump to limit the pump pressure.
- Set the minimum power switch off so as to avoid a dry run of the pump at highly reduced maximum power consumption (e. g. if leaking).

The pump is preset to a standard value for the maximum power switch off. The manufacturer recommends that with smaller flow rates the standard value for the maximum power switch off should be insignificantly decreased.

Legend

- ① Maximum value
- ② Minimum value

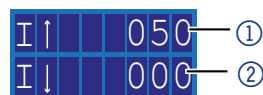

Note: 22 Setting maximum and minimum power switch off



Note: If the minimum is set to 0, the minimum power consumption is not monitored.

Procedure

1. To scroll through, press both buttons simultaneously.



Fig. 23 Arrow buttons

2. When the cursor flashes, use the arrow keys again to set the value for the maximum power consumption.



Fig. 24 Maximum current admission

3. Hold down the left arrow key. Press right arrow key once.

4. When the cursor flashes, use the arrow keys again to set the value for the minimum power consumption.



Fig. 25 Minimum power consumption

5. Press start/stop key once to return to the start display.

Result The setting is completed. If the maximum pressure is exceeded, the pump switches off.

6.2.2.4 Piston seal wash

When you flush the piston seal regularly, the service life of the seal and the piston increases. While flushing, contaminants are washed from the backpiston space.

The following solvents are recommended for flushing:

- Water
- Mixture of 80 % water and 20 % ethanol
- Isopropanol

Procedure **Figure**

1. Connect the outlet to the waste container with a hose ① .
2. Connect the inlet to the syringe with a hose ② .
3. Fill up flushing solution with the syringe through the pump head until there are no more air bubbles running through the waste bottle.
4. Afterwards, remove the hoses and connect inlet and outlet with a hose.

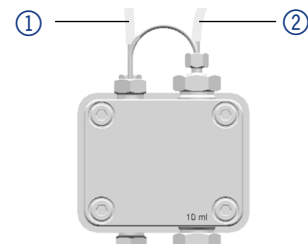

Fig.26 Backpiston wash

6.2.3 Choosing pump head

Procedure **Figure**

1. To scroll through, press both buttons simultaneously.
2. Scroll with the right arrow key until 10 ml / 50 ml is displayed.



Fig.27 Choosing pump head

Result When setting is finished, the status display appears.



Note: Configuring the pump heads 10 ml or 50 ml, the maximum pressure for the respective pump head is applied automatically. Check the allowed maximum pressure for the pump head.

6.2.4 Flushing the pump

The display shows vertical arrows while the pump is flushing.

Legend

- ① Symbol for flushing procedure
- ② Pressure in 0.1 MPa (only for P 4.1S)
- ③ Flow rate



Fig.28 Indication of the flushing process in the display

Prerequisites

Pump with pressure sensor:

- Venting screw of the pressure sensor is open.
- A jar or a hose to the waste container was set up.

Pump without pressure sensor:

- Cap fitting on the pump head outlet is removed.
- A jar or a hose to the waste container was set up.
- Fitting on the pump head outlet ist removed.
- Venting syringe with screw connection at the pump head outlet is screwed on.



Note: The flow rate can be changed while being purged. The change takes effect immediately.

Procedure

1. Prime liquid with the syringe.
2. Hold down start/stop key until flushing starts.

Figure**Fig. 29** Start/Stop key**6.2.5 Software**

To be able to control the pump using chromatography software, the computer has to be connected to the device either with a RS-232 cable or a LAN cable.

6.2.5.1 Via Local Area Network (LAN)

A device connected to a LAN is recognized by the software and automatically receives an IP address because it is set to Dynamic Host Configuration Protocol (DHCP) at the factory.

Prerequisites

- Device has been connected to LAN.
- Status display is active.

Procedure

1. To scroll through, press both buttons simultaneously.
2. Using the arrow buttons, scroll until it shows LAN.

Figure**Fig. 30** Display control

Result When setting is finished, the status display appears.

6.2.5.2 Via RS-232 port**Prerequisites**

- Interface RS-232 is connected.
- Status display is active.

Procedure

1. To scroll through, press both buttons simultaneously.
2. Using the arrow buttons, scroll until it shows RS-232.

Figure**Fig. 31** Display control

Result When setting is finished, the status display appears.

6.2.5.3 Control commands

The control commands listed below are considered for the communication with RS-232 and LAN. When entering a parameter, you have to place a colon or space between command and parameter value, e.g. PMIN10:100. Consider the following specifications for data transfer with RS-232 interface:

- 9600 baud
- 8 bit
- 1 stop bit
- no parity check

Control command	Range and specification	Description
ADJ10(?)	RD/WR 100-2000	Adjust parameter for 10 ml pump head
ADJ50(?)	RD/WR 100-2000	Adjust parameter for 50 ml pump head
CORR10(?)	RD/WR 0-300	Correction parameter for 10 ml pump head
CORR50(?)	RD/WR 0-300	Correction parameter for 50 ml pump head
FLOW(?)	RD/WR 0-50000	Writing/reading the flow in $\mu\text{l}/\text{min}$
PRESSURE?	RD 0-400	Pressure readout in 0.1 MPa
PMIN10(?)	RD/WR 0-400	Minimum pressure for 10 ml pump head (in 0.1 MPa)
PMIN50(?)	RD/WR 0-150	Minimum pressure for 50 ml pump head (in 0.1 MPa)
PMAX10(?)	RD/WR 0-400	Maximum pressure for 10 ml pump head (in 0.1 MPa)
PMAX50(?)	RD/WR 0-150	Maximum pressure for 50 ml pump head (in 0.1 MPa)
IMIN10(?)	RD/WR 0-100	Minimum motor current for 10 ml pump head
IMIN50(?)	RD/WR 0-100	Minimum motor current for 50 ml pump head
IMAX10(?)	RD/WR 0-100	Maximum motor current for 10 ml pump head
IMAX50(?)	RD/WR 0-100	Maximum motor current for 50 ml pump head
HEADTYPE(?)	RD/WR 10, 50	Writing/reading the pump-head type
STARTLEVEL(?)	RD/WR 0.1	Configures START IN. 0 = Pump starts the flow at short circuit contact only (Start In <> Ground). 1 = Pump starts the flow without a short circuit contact (Start In <> Ground).
ERRIO(?)	RD/WR 0.1	Writing/reading the ERROR input/output, OUT (0) or IN (1)
STARTMODE(?)	RD/WR 0.1	0 = Pump pauses after switch-on. 1 = Pump starts immediately after switch-on with the previous set flow rate.
EXTCONTR	WR 0.1	0 = prevents external flow control 1 = allows the flow rate control via analog input 0 - 10 V (10 ml: 1 V = 1 ml/min, 50 ml: 1 V = 5 ml/min)
EXTFLOW?	RD	
IMOTOR?	RD 0-100	Motor current in relative units
LOCAL	WR	Command for releasing the pump to change the settings manually (control command to cancel the remote command)
REMOTE	WR	Command to prevent a manual parameter input, with exception of stopping the flow via START/STOP button.
ERRORS?	RD	Display of the last 5 error codes.
ON	WR	Starts the flow
OFF	WR	Stops the flow

6.2.5.4 Activating the analog control (prior to firmware version 1.37)

The analog control is switched on and off via a serial port RS-232 with an applicable hyperterminal program.

- Prerequisites**
- The serial port RS-232 is wired and set up successfully. The pump is connected with the control PC via an available COM port.
 - An applicable hyperterminal program is available on the PC.
 - Status display is active.

Procedure

1. To scroll through, press both buttons simultaneously.
2. Using the arrow buttons, scroll until it shows RS-232.

Figure



Fig.32 Display control

3. In the Hyperterminal program, enter the EXTCONTR: 1 command (see "control-commands" Page 24).

Result The display shows a star symbol left to the flow rate.

You cannot adjust the flow rate any longer via the key pad.

To deactivate the analog control, enter "0" instead of "1" as parameter for EXTCONTR.

6.2.5.5 Adjusting the analog control (prior to firmware version 1.37)

If you adjust the pump via analog control, the start setting changes at switch-on. In analog operation, the pump starts with switched on flow only. The flow rate corresponds to the wired voltage. The contact between GROUND and START IN has to be closed to start the pump.

In addition, it is possible to send commands to the pump via RS-232 or LAN.



Note: It is only possible to use the communication connection which has been chosen before the adjustment (RS-232 or LAN).

If you reset the pump to RS-232 or LAN, the device is set to standard settings. The pump does not start with switched on flow. The flow stops at active short circuit connection GROUND and START IN.

- Prerequisites**
- Interfaces ANALOG IN, GROUND and START IN, GROUND of pin header is wired.
 - Status display is active.

Procedure

1. To scroll through, press both buttons simultaneously.
2. Using the right arrow buttons, scroll until it shows ANALOG.

Figure



Fig.33 Display control

Result The display shows a star symbol left to the flow rate. You cannot adjust the flow rate any longer via the key pad. To deactivate the analog control, choose RS-232 or LAN in the menu. In this case, the starting parameter of the pump are reset (START IN, START mode) and you can use the pump as usual.

6.2.5.6 Controlling the flow rate analog

For the flow rate control, choose analog in the selection menu via an external control voltage. This is valid from firmware version 1.37, for older versions please contact the Technical Support.



Note: The parameter can be changed via a terminal connection. Deactivating and activating the analog control, the parameter has to be set again. Alternative: Installation of a permanent short circuit connection.

Legend

- ① Pressure in 0.1 MPa
- ② Flow rate in ml/min



Fig.34 Status display

Prerequisites The pump is connected to the power supply.

Procedure

1. Apply control voltage.
2. Press the Start/Stop button, so as to start the pump. The star symbol on the display of the pump indicates that the pump is working with an externally controlled flow rate.
3. To stop the pump, press the start/stop button again.

6.2.5.7 Starting with a short-circuit

Connection for the short circuit (or TTL-low) for interrupting and continuing the operation of the pump. The operation of the pump is dependent on the STARTLEVEL setting:

- STARTLEVEL 1 (default setting RS-232, LAN): The pump does not operate during the time of short-circuit.
- STARTLEVEL 0 (default setting analog): The pump operates during the time of short-circuit.

Legend

- ① Pressure in 0.1 MPa
- ② Flow rate in ml/min



Fig.35 Status display

Enter STARTLEVEL:1 in the terminal program, so that the pump does not operate for the duration of the short circuit.

Prerequisites The pump is connected to the power supply.



Note: During the interruption, the horizontal arrow (A) remains in the display, because the pump is still in operation status.

Procedure

1. Connect the pump with an applicable terminal program.
2. Connect the pump using a LAN or RS-232.
3. Enter STARTLEVEL:1.

6.2.5.8 Starting directly after connection to power supply

By default the pump is stopped and started using the start/stop button. The STARTMODE setting allows you to start the device right after connecting it to power supply.

- STARTMODE 0 (default setting RS-232, LAN): The pump does not start operating right after being connected to power supply.
- STARTMODE 1 (default setting analog): The pump starts operating right after being connected to power supply.

If you have to change the start mode choose the command STARTMODE 0. Deactivating and activating the analog control, the parameter has to be set again.

Prerequisites ■ The pump is connected to the power supply.

Procedure

1. Connect the pump with an applicable terminal program.
2. Connect the pump using a LAN or RS-232.
3. Enter STARTMODE:1.

6.3 Switching off the pump

If you want to switch off the pump for a longer term, flush the pump head with isopropanol.

Prerequisites

- The pump has been rinsed. Use isopropanol before a long-term commissioning or to prepare for storage.
- The pump is out of use.

Procedure

1. Stop the flow.
2. Switch off the power switch of the power adapter on the back of the device.

Result The display turns off.

7. Functionality tests



Note: Standard processes regarding IQ and OQ in single devices may be handled differently in individual cases.

7.1 Installation Qualification (IQ)

The customer may request the Installation Qualification, which is free of charge. In case of a request, the technical support of KNAUER or a provider authorized by KNAUER performs this functionality test during the installation.

The Installation Qualification is a standardized document that includes the following:

- confirmation of flawless condition at delivery
- check if the delivery is complete
- certification on the functionality of the device

You can either use the IQ document attached to this instruction manual or download a digital version from our website:



7.2 Operation Qualification (OQ)

The Operation Qualification includes an extensive functionality test according to KNAUER standard OQ documents. The Operation Qualification is a standardized document and free of charge. It is not part of the delivery. Please contact the technical support in case of a request.

The Operation Qualification includes the following:

- definition of customer requirements and acceptance terms
- documentation on device specifications
- device functionality check at installation site

Test intervals

To make sure that the device operates within the specified range, you should test the device regularly. The test intervals depend on the usage of the device.

Execution

The test can be carried out either by the technical support of KNAUER or by a provider authorized by KNAUER (for a fee). For further information visit our website:



8. Troubleshooting



- First measures**
1. Check all cabling.
 2. Check all screw fittings.
 3. Check whether air has gotten into the supply lines.
 4. Check device for leaks.
 5. Pay attention to system messages.

Further measures Inform the Technical Support of KNAUER.

8.1 LAN

Go through the following steps, in case no connection between the computer and the devices can be established. Check after each step if the problem is solved. If the problem cannot be located, call the Technical Support.

1. Check the status of the LAN connection in the Windows task bar:

-  Connected
-  Connection not established

If no connection was established, check the following:

- Is the router switched on?
 - Is the patch cable connected correctly to the router and the computer?
2. Check the router settings:
 - Is the router set to DHCP server?
 - Is the IP address range sufficient for all the connected devices?
 3. Check all connections:
 - Are the patch cable connected to the LAN ports and not the WAN port?
 - Are all cable connections between devices and router correct?
 - Are the cables plugged in tightly?
 4. If the router is integrated into a company network, pull out the patch cable from the WAN port.
 - Can the devices communicate with the computer, even though the router is disconnected from the company network?
 5. Turn off all devices, router, and computer. First switch on the router and wait until it has successfully completed its self-test. Then turn on the devices and the computer.
 - Has this been successful?
 6. Replace the patch cable to the device with that no connection could be established.
 - Has this been successful?
 7. Make sure that the IP port of the device matches the port in the chromatography software.

8.2 Possible problems and solutions

Problem	Solution
Pump does not turn on	<p>Power cable needs to be connected to power supply and power adapter has to be turned on.</p> <ul style="list-style-type: none"> Check the power cable to ensure that it is plugged into the power supply.
When flushing (Purge) the pump turns off.	<p>The venting screw on the pressure sensor has to be turned up.</p> <ul style="list-style-type: none"> Check if the venting screw on the pressure sensor is turned open.
Pump does not transport solvent	<p>Check the following options:</p> <ul style="list-style-type: none"> Purge the pump head so as to remove the air bubbles Check the eluent inlet and filter of the HPLC column and replace when blocked. Cleaning the check valves Changing the check valves If the pump head seals are defective, solvent enters the backpiston space resulting in a volume increase visible in the piston seal wash bottle; inform the technical support of the manufacturer.
Pressure or flow rate fluctuations	<p>Check the following options:</p> <ul style="list-style-type: none"> Purge the pump head so as to remove the air bubbles Always tighten the inlet screw 1 and outlet screw 1 on the pump head with a torque wrench (7.5 Nm for stainless steel, 3 Nm for ceramic). Cleaning the check valves Changing the check valves
Pump head leaks	<p>Check the following options:</p> <ul style="list-style-type: none"> Inspect the inlet and outlet screw fittings of the pump head Replacing the pump head If the pump head seals are defective, solvent enters the piston backflushing; inform the technical support of the manufacturer.
Flow rate is not correct	<p>Check the following options:</p> <ul style="list-style-type: none"> Inspect the inlet and outlet screw fittings of the pump head Cleaning the check valves Changing the check valves Replacing the pump head Pump without pressure sensor: Pay attention to the influence of the pressure on the flow rate (will not be compensated). Inform the technical support of the manufacturer.

Further measures Inform the Technical Support of KNAUER.

9. Maintenance and care

Proper maintenance of your HPLC device will ensure successful analyses and reproducible results. In this chapter, you find the information relevant for maintenance, care and storage. Additionally, you find instructions for maintenance tasks that may be performed by the customer. In case there are any maintenance tasks on that you do not find instructions here, contact your supplier or the Technical Support.

9.1 Maintenance contract

The following maintenance work on the device may only be performed by KNAUER or a company authorized by KNAUER and is covered by a separate maintenance contract:

- Opening the device.
- Removing the hood or the side panels.

9.2 Cleaning and caring for the device

NOTICE

Device defect

Intruding liquids can cause damage to the device.

- Place solvent bottles next to the device or in a solvent tray.
- Moisten the cleaning cloth only slightly.

All smooth surfaces of the device can be cleaned with a mild, commercially available cleaning solution, or with isopropanol.

9.3 Which type of maintenance tasks may users perform on the device?

The following maintenance tasks are recommended by the manufacturer and may be performed by the user.

- Replacing the pump head
- Exchanging the check valves

9.3.1 Pump head

9.3.1.1 Torque values

Pump head	Type (ml)	Screw fitting Fitting, outlet (Nm)	Screw fitting, inlet (Nm)	Capillary connection (Nm)
AHB40	10	7.5	3.5	5.0
AHB40BA				
AHB40CA				
AHB32	10	3.5	3.5	1.0 (finger tight)
AHB32DA				
AHB43	10	7.5	7.5	5.0
AHC22	50	3.5	3.5	1.0 (finger tight)
AHC23	50	7.5	7.5	5.0
AHC20	50	7.5	7.5	5.0
AHC20BA	10	7.5	3.5	5.0
AHC20CA	50	7.5	7.5	5.0

9.3.1.2 Removing the pump head

Prerequisites The pump head has been flushed with suitable solvent.

⚠ WARNING

Chemical burns

Skin damage from aggressive or toxic eluents.

- Wear protective gloves.
- Flush the pump head before changing.

NOTICE

Component defect

Possible damage to the pump piston by tilting the pump head.

- Tighten diagonally opposite fastening screws evenly one turn at a time.
- Also loosen the fastening screws evenly.

Procedure

1. Loosen inlet fitting ② and outlet fitting ①.
2. Loosen the piston seal wash tubings ④.
3. Loosen 4 fixing screws ③ alternately and hold the pump head.

Figure

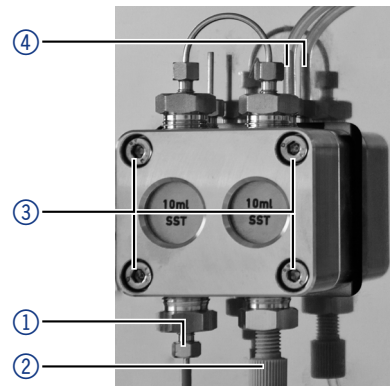

Fig.36 Removing the pump head

9.3.1.3 Installing the pump head

NOTICE

Component defect

Possible damage to the pump head due to over-tightened capillary fitting.

- Note the torque of the screw connection.

Procedure

1. Tighten 4 fixing screws ③ alternately and hold the pump head.
2. Mount the piston seal wash tubings ④.
3. Tighten the inlet fitting ② and the outlet fitting ①.

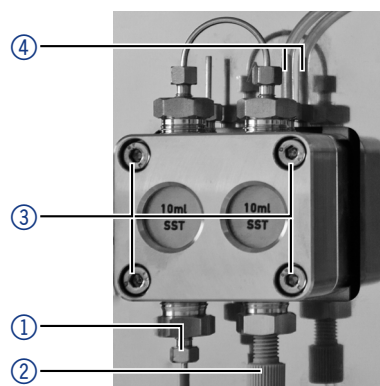
Figure**Fig.37** Installing the pump head**9.3.2 Check valves**

Clogged check valves do not open and close properly. They cause pressure fluctuations and irregular flow.



Note: Insert the check valves in the direction of the flow.

9.3.3 Removing the check valves**Prerequisites**

- The pump head has been purged.
- The capillaries and tubings have been removed.

Tools

- Open-end wrench, size 13

Procedure

1. Unscrew and remove the capillary connector ①.
2. Loosen the outlet fitting ② with the open-end wrench.
3. Remove the first check valve.
4. Loosen the eluent connection ④.
5. Loosen the inlet fitting ③ with the open-end wrench.
6. Remove the second check valve.

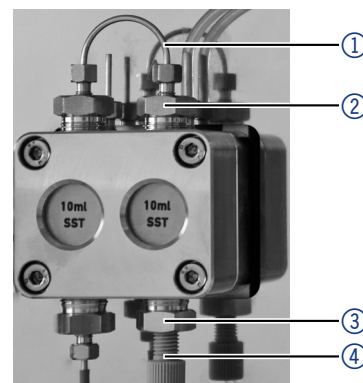
Figure**Fig.38** Removing the check valves**Next steps**

- Clean the check valves.

9.3.4 Cleaning the check valves**Procedure**

1. Fill a beaker with solvent.
2. Place the valve in the beaker.
3. Put the beaker in an ultrasonic bath for at least 10 minutes.

Another way to clean clogged check valves is to blow them out with **compressed air**.

9.3.5 Installing the check valves

Insert the check valves in the direction of the flow. The notch of the check valve points downward. Insert the NP check valves in the direction of the flow. The arrow on the NP check valve points upward.

- Prerequisites**
- The check valves have dried.

NOTICE

Component defect

Damage to components due to excessive tightening possible. Observe the torque of the screw connection.

- Use 5 Nm torque for stainless steel fittings.
- Use 1 Nm torque for PEEK fittings.

Procedure

Figure

1. Insert the check valves ① so that the notch of the check valve ② points downwards. In the case of NP check valves, observe the direction of the arrow.
2. Manually screw in inlet and outlet fittings and tighten them with a torque wrench and the respective torque.

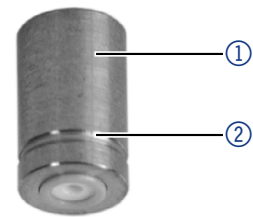

Fig.39 Check valve

- Next steps**
- Re-install the pump head.

10. Technical data



Note: The pump was adjusted under specific conditions. If the pump is operated under different conditions (flow, pressure, eluent), a calibration of the pump may be necessary at the selected place of operation.

10.1 General

Pump type	Dual-piston pump with main and auxiliary piston
Flow rate range	<ul style="list-style-type: none"> ■ 10 ml pump head: 0.001-10 ml/min ■ 50 ml pump head: 0.01-50 ml/min
Precision of the flow rate	<ul style="list-style-type: none"> ■ P 4.1S: $\pm 2\%$ (1 ml/min) ■ P 2.1S: $\pm 5\%$ (1 ml/min) ■ For pumps without a pressure sensor dependent on pressure
Reproducibility of the flow rate	Relative standard deviation RSD: < 0.5 % (1 ml/min)
Gradient support	<ul style="list-style-type: none"> ■ Isocratic HPLC pump ■ Expandable to a binary high pressure gradient system (controlled by software)
System protection	<ul style="list-style-type: none"> ■ Pump with pressure sensor: P_{min} and P_{max} adjustable I_{min} and I_{max} adjustable ■ Pump with pressure sensor: I_{min} and I_{max} adjustable
Wetted materials	<p>For ceramic:</p> <p>Graphite fiber reinforced PTFE, FKM, PEEK, sapphire, aluminum oxide (Al₂O₃), titanium (only P 4.1S)</p> <p>For stainless steel:</p> <p>Stainless steel, graphite fiber reinforced PTFE, FKM, PEEK, sapphire, aluminum oxide (Al₂O₃), titanium (only P 4.1S)</p> <p>For Hastelloy® C:</p> <p>Hastelloy® C, graphite fiber reinforced PTFE, FFKM, KEL-F, sapphire, aluminium oxide (Al₂O₃), zirconium oxide (ZrO₂), titanium (only P 4.1S)</p>

10.2 Communication

Control	<ul style="list-style-type: none"> ■ RS-232 ■ LAN ■ Analog ■ Buttons on the device
Analog Inputs	0-10 V

10.3 Technical parameters

Supply frequency	See type plate of the power supply
Power consumption	Maximum 40 W at the 24 V connection of the pump
Protection type	IP 20
Temperature range	4-40 °C / 39.2-104 °F
Air humidity	Below 90 % non-condensing
Power supply	See type plate of the power supply
Dimensions (width x height x depth)	<ul style="list-style-type: none"> ■ Pump without pressure sensor: 121 mm x 129.1 mm x 220.2 mm ■ Pump with pressure sensor: 121 mm x 129.1 mm x 228 mm
Weight	<ul style="list-style-type: none"> ■ Pump without pressure sensor: 2.3 kg ■ Pump with pressure sensor: 2.4 kg

10.4 Dimensions

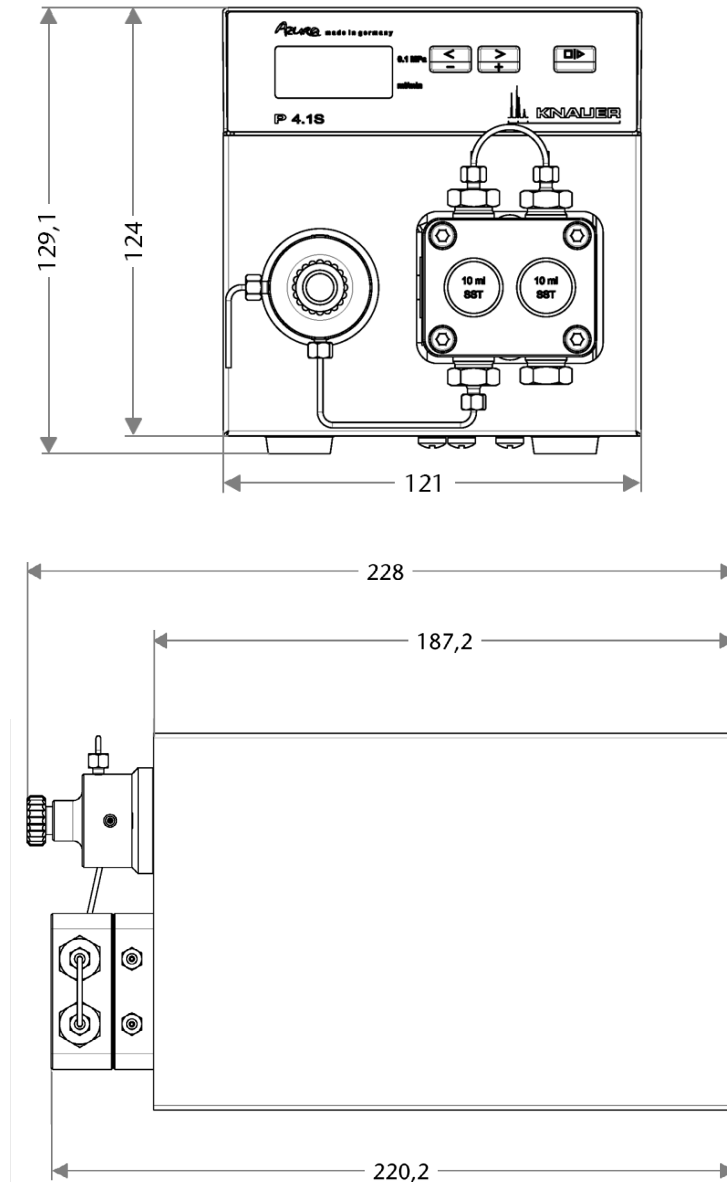

Fig.40 Dimensions of the pump in mm

11. Chemical compatibility of wetted materials



Note: The user takes the responsibility for using the fluids and chemicals in an appropriate and safe way. If there is any doubt, contact the Technical Support of the manufacturer.

11.1 General

The device is very resistant against a variety of commonly used eluents. However, make sure that no eluents or water come in contact with the device or enter into the device. Some organic solvents (such as chlorinated hydrocarbons, ether) may cause coating damage or loosen glued components by improper handling. Even small quantities of other substances, such as additives, modifiers, or salts can influence the durability of the materials. Exposure time and concentration have a high impact on the resistance.

The following list contains information about the chemical compatibility of all wetted materials which are used in devices made by KNAUER. The data bases on a literature research on the manufacturer specifications of the materials. The wetted materials of this device are listed in the chapter „Technical data“.

All resistances mentioned here are for use at temperatures up to 40 °C, unless stated otherwise.

Note that higher temperatures can significantly affect the stability of different materials.

11.2 Plastics

11.2.1 Polyetheretherketone (PEEK):

PEEK is a durable and resistant plastic and, apart from stainless steel, the standard material in HPLC. It can be used at temperatures up to 100 °C and is highly chemical resistant against almost all commonly used solvents in a pH range of 1-12,5. PEEK is potentially moderate resistant against oxidizing and reducing solvents.

Therefore, following solvents should not be used: Concentrated and oxidizing acids (such as nitric acid solution, sulfuric acid), halogenated acids (such as hydrofluoric acid, hydrobromic acid) and gaseous halogens. Hydrochloric acid is approved for most applications.

In addition, following solvents can have a swelling effect and may have an impact on the functionality of the built-in components: Methylene chloride, THF and DMSO in any concentration such as acetonitrile in higher concentrations.

11.2.2 Polyethylene terephthalate (PET, outdated PETP)

PET is a thermoplastic and semi-crystalline material with high wear resistance. It is resistant against diluted acids, aliphatic and aromatic hydrocarbons, oils, fats and alcohols, but not against halogenated hydrocarbons and ketones. Since PET belongs chemically to esters, it is not compatible with inorganic acids, hot water and alkalis. Maximum operating Temperature: up to 120 °C.

11.2.3 Polyimide (Vespel®):

This material is wear-resistant and permanent resilient thermally (up to 200 °C) as well as mechanically. It is chemically broadly inert (pH range 1-10) and is especially resistant against acidic to neutral and organic solvents, but vulnerable to pH strong chemical or oxidizing environments: It is incompatible with concentrated mineral acids (such as sulfuric acid), glacial acetic acid, DMSO and THF. In addition, it will be disintegrated by nucleophilic substances like ammonia (such as ammonium salts under alkaline conditions) or acetate.

11.2.4 Ethylene-tetrafluorethylene copolymer (ETFC, Tefzel®):

This fluorinated polymer is highly resistant against neutral and alkaline solvents. Some chlorinated chemicals in connection with this material should be handled with care. Maximum operating Temperature is 80 °C.

11.2.5 Perfluorethylenpropylen-Copolymer (FEP), Perfluoralkoxy-Polymer (PFA)

These fluorinated polymers hold similar features as PTFE, but with a lower operation temperature (up to 205 °C). PFA is suitable for ultrapure applications, FEP can be used universally. They are resistant against almost all organic and inorganic chemicals, except elemental fluorine under pressure or at high temperatures and fluorine-halogen compounds.

11.2.6 Polyoxymethylene (POM, POM-H-TF):

POM is a semi-crystalline, high-molecular thermoplastic material which stands out due to its high stiffness, low friction value and thermic stability. It can even substitute metal in many cases. POM-H-TF is a combination of PTFE fibres and acetal resin and is softer and has better slip properties as POM. The material is resistant against diluted acids (pH > 4) as well as diluted lyes, aliphatic, aromatic and halogenated hydrocarbons, oils and alcohols. It is not compatible with concentrated acids, hydrofluoric acid and oxidizing agent. Maximum operating Temperature is 100 °C.

11.2.7 Polyphenylene sulfide (PPS)

PPS is a soft polymer which is known for its high break resistance and very high chemical compatibility. It can be used with most organic, pH neutral to pH high, and aqueous solvents at room temperature without concerns. However, it is not recommended for using with chlorinated, oxidizing and reducing solvents, inorganic acids or at higher temperatures. Maximum operating temperature: 50 °C.

11.2.8 Polytetrafluorethylene (PTFE, Teflon®):

PTFE is very soft and anti-adhesive. This material is resistant against almost all acids, lyes and solvents, except against fluid sodium and fluoride compounds. In addition, it is temperature-resistant from -200 °C to +260 °C.

11.2.9 Systec AF™:

This amorphous perfluorinated copolymer is inert against all commonly used solvents. However, it is soluble in perfluorinated solvents like Fluorinert® FC-75 and FC-40, and Fomblin perfluor-polyether solvents from Ausimont. In addition, it is affected by Freon® solvents.

11.2.10 Polychlorotrifluorethylene (PCTFE, Kel-F®):

The semi-crystalline thermoplastic material is plasticizer-free and dimensionally stable, even in a wide temperature range (-240 °C to +205 °C). It is moderately resistant against ether, halogenated solvents and toluene. Halogenated solvents over +60 °C and chlorine gas should not be used.

11.2.11 Fluorinated rubber (FKM):

The elastomer consisting of fluorinated hydrocarbon stands out due to a high resistance against mineral oils, synthetic hydraulic fluids, fuels, aromatics, and many organic solvents and chemicals. However, it is not compatible with strong alkaline solvents (pH value >13) like ammonia, and acidic solvents (pH value <1), pyrrole and THF. Operating temperature: Between -40 °C and +200 °C.

11.2.12 Perfluorinated rubber (FFKM):

This perfluoro elastomer has a higher fluorine content as fluorinated rubber and is therefore chemically more resistant. It can be employed at higher temperatures (up to 275 °C). It is not compatible with Pyrrole.

11.3 Non-metals

11.3.1 Diamond-like carbon (DLC)

Diamond-like carbon (DLC) is characterized by a high hardness, a low coefficient of friction and thus low wear. In addition, it is highly biocompatible. DLC is inert against all acids, alkalis and solvents commonly used in HPLC.

11.3.2 Ceramic

Ceramic is resistant against corrosion and wear and is fully biocompatible. An incompatibility against acids, alkalis and solvents commonly used in HPLC is not known.

11.3.3 Alumina (Al₂O₃)

Due to their high resistance to wear and corrosion, alumina ceramic is used as a coating for mechanically stressed surfaces.

It is a biocompatible material with low thermal conductivity and low thermal expansion.

11.3.4 Zirconium oxide (ZrO₂)

Zirconia ceramics are characterized by their high mechanical resistance, which makes them particularly resistant to wear and corrosion.

It is also biocompatible, has low thermal conductivity and is resistant to high pressures.

11.3.5 Sapphire

Synthetic sapphire is virtually pure monocrystalline alumina.

It is biocompatible and very resistant to corrosion and wear.

The material is characterized by a high hardness and a high thermal conductivity.

11.3.6 Ruby

Synthetic ruby is monocrystalline alumina and gets its red color by the addition of some chromium oxide. It is biocompatible and very resistant to corrosion and wear. The material is characterized by a high hardness and a high thermal conductivity.

11.3.7 Mineral wool

This insulating material consists of glass or stone wool fibres and isolates in high oxidizing conditions and at high temperatures. Mineral wool is valid as commonly inert against organic solvents and acids.

11.3.8 Glass, glass fibre, quartz, quartz glass:

These mineral materials are resistant against corrosion and wear and are mostly chemical inert. They are compatible with oils, fats and solvents and show a high resistance against acids and lyes up to pH values of 3-9. Concentrated acids (especially hydrofluoric acid) may embrittle and corrode the minerals. Lyes may ablate the surfaces slowly.

11.4 Metals

11.4.1 Stainless steel

Stainless steel is, apart from PEEK, the standard material in HPLC. Steels with WNr. 1.4404 (316L) are used, or with a mixture of higher compatibility. They are inert against almost all solvents. Exceptions are biological applications which are metal ion sensitive, and applications with extreme corrosive conditions. These steels, in comparison to commonly used steels, are increasingly resistant against hydrochloric acid, cyanides and other halogen acids, chlorides and chlorinated solvents.

The use in ion chromatography is not recommended. In case of electrochemical applications, a passivation has to be executed first.

11.4.2 Hastelloy®-C:

This nickel-chrome-molybdenum alloy is extremely resistant to corrosion, especially against oxidizing, reducing and mixed solvents, even at high temperatures. This alloy may be used in combination with chlorine, formic acid, acetic acid and saline solutions.

11.4.3 Titanium, titanium alloy (TiA16V4):

Titanium has a low weight and a high hardness and stability. It stands out due to its very high chemical compatibility and bio-compatibility. Titan is applied when neither stainless steel nor PEEK are usable.

12. Repeat orders

For repeat orders of spare parts use the enclosed packing list. Contact the Technical Support in case there are any questions on spare parts or accessories.

12.1 Accessories

Name	Order Number
AZURA® accessories kit	FZA01
AZURA® Pump P 2.1S/P 4.1S accessories kit	FPGA
Maintenance kit for 10 ml pump head	A96423
Maintenance kit for 10 ml pump head Hastelloy-C	A964231
Maintenance kit for 10 ml pump head for water application	A964232
Maintenance kit for 50 ml pump head	A96424
Maintenance kit for 50 ml pump head Hastelloy-C	A964233
Rebuild-kit for 10 ml pump head KEL-F valve cover, FFKM O-ring	A5821-1
Rebuild-kit for 50 ml pump head KEL-F valve cover, FFKM O-ring	A5821-2
Rebuild-kit for 10 ml pump head for water application sapphire piston, GFPseals, FKM O-rings	A5823
Inlet-bushing kit for 1/8" capillary for 10 ml pump head	A58202
Inlet-bushing kit for 1/16" capillary for 10 ml pump head	A58203
Inlet-bushing kit für 1/16" capillary for 50 ml pump head and 10 ml pump head, ceramic	A58205
Deaeration screw KEL-F	A1644
Instructions	V6870
Mobile Control license with 10" touchscreen	A9607
Mobile Control Chrom license with 10" touchscreen	A9608
Mobile Control license	A9610
Mobile Control Chrom license	A9612

12.2 Device variants

Name	Order Number
AZURA® Pump P 4.1S without pump head	APG20
AZURA® Pump P 4.1S with 10 ml stainless steel pump head	APG20EA
AZURA® Pump P 4.1S with 10 ml ceramic pump head	APG20EB
AZURA® Pump P 4.1S with 10 ml pump head Hastelloy-C	APG20EC
AZURA® Pump P 4.1S with 10 ml ceramic pump head, titanium fittings	APG20EF
AZURA® Pump P 4.1S with 10 ml pump head (stainless steel, for water application)	APG20EG
AZURA® Pump P 4.1S with 10 ml pump head (ceramic, for water application), titanium fittings	APG20EH
AZURA® Pump P 4.1S with 50 ml stainless steel pump head	APG20FA
AZURA® Pump P 4.1S with 50 ml ceramic pump head	APG20FB
AZURA® Pump P 4.1S with 50 ml Hastelloy-C pump head	APG20FC
AZURA® Pump P 2.1S without pump head	APG90
AZURA® Pump P 2.1S with 10 ml stainless steel pump head	APG90EA
AZURA® Pump P 2.1S with 10 ml ceramic pump head	APG90EB
AZURA® Pump P 2.1S with 10 ml Hastelloy-C pump head	APG90EC
AZURA® Pump P 2.1S with 50 ml stainless steel pump head	APG90FA
AZURA® Pump P 2.1S with 50 ml ceramic pump head	APG90FB
AZURA® Pump P 2.1S with 50 ml Hastelloy-C pump head	APG90FC
AZURA® Pump P 2.1 S with 50 ml pump head (stainless steel, for water application)	APG90FG

12.3 Available pump heads

Name	Order Number
10 ml stainless steel pump head with stainless steel inlay	AHB40
10 ml pump head with ceramic inlay	AHB32
10 ml pump head with ceramic inlay and titanium fittings	AHB32DA
10 ml pump head with Hastelloy-C inlay	AHB43
10 ml pump head stainless steel for normal phase applications	AHB40BA
10 ml pump head stainless steel for water application	AHB40FA
50 ml pump head with ceramic inlay	AHC22
50 ml pump head with Hastelloy-C inlay, for corrosive media	AHC23
50 ml stainless steel pump head with stainless steel inlay	AHC20
50 ml stainless steel pump head for normal phase application	AHC20BA

13. Legal information

13.1 Transport damage

The packaging of our devices provides the best possible protection against transport damage. Check the devices for signs of transport damage. In case you notice any damage, contact the technical support and the forwarder company within three workdays.

13.2 Warranty conditions

The factory warranty for the device is contractually agreed. During the warranty period, any components with material or design-related defects will be replaced or repaired by the manufacturer free of charge. Please check the terms and conditions on our website.

All warranty claims shall expire in the event that any unauthorized changes are made to the device. Also excluded from the warranty:

- Accidental or willful damage
- Damage or errors caused by third parties that are not contractually related to the manufacturer at the time the damage occurs
- Wear parts, fuses, glass parts, columns, light sources, cuvettes and other optical components
- Damage caused by negligence or improper operation of the device and damage caused by clogged capillaries
- Packaging and transport damage

In the event of device malfunctions, directly contact the manufacturer.

KNAUER Wissenschaftliche Geräte GmbH
Hegauer Weg 38
14163 Berlin, Germany

Telephone: +49 30 809727-111

Telefax: +49 30 8015010

E-mail: support@knauer.net

Internet: www.knauer.net

13.3 Declaration of conformity

The Declaration of Conformity accompanies the product as a separate document and is available online:

www.knauer.net/en/Support/Declarations-of-conformity

14. Disposal

Hand in old devices or disassembled old components at a certified waste facility, where they will be disposed of properly.

14.1 AVV-Marking Germany

According to the German "Abfallverzeichnisverordnung" (AVV, January, 2001), old devices manufactured by KNAUER are marked as waste electrical and electronic equipment: 160214. 160214.

14.2 WEEE-Registration number

KNAUER as a company is registered by the WEEE number DE 34642789 in the German "Elektroaltgeräteregister" (EAR). The number belongs to category 8 and 9, which, among others, comprise laboratory equipment.



All distributors and importers are responsible for the disposal of old devices, as defined by the WEEE directive. End-users can send their old devices manufactured by KNAUER back to the distributor, the importer, or the company free of charge, but would be charged for the disposal.

14.3 Eluents and other operating materials

All eluents and other operating materials have to be collected separately and disposed of properly. All wetter components of a device, e. g. flow cells of detectors or pump heads and pressure sensors for pumps, have to be flushed with isopropanol first and water afterwards before being maintained, disassembled or disposed.

Appendix: Installation Qualification (IQ)

Installation Qualification (IQ) for a Device

	Created	Reviewed	Approved
Function	Technical editor	Engineering	Head of Quality
Name	Anna Erben	Paul Pietsch	Kate Monks
Date	23/08/2022	29/08/2022	30/08/2022
Signature	 <small>Digital unterschrieben von Anna Erben Datum: 2022.08.23 14:09:27 +02'00'</small>		

0. Customer approval

Prior to installation at the customer site, the customer has reviewed the OQ document and agrees with the design and scope

Company name:

Name	Function	Reviewed & approved	Date	Signature

Installation Qualification (IQ) for a Device

1. Definition of the Installation Qualification

The qualification document „Installation Qualification (IQ)“ is part of the quality management system at the company KNAUER Wissenschaftliche Geräte GmbH.

2. Scope

The customer can request the Installation Qualification. In case of a request, the technical support of KNAUER or a provider authorized by KNAUER performs this functionality test during the installation. The IQ is a standardized document and includes the following:

- Confirmation of flawless condition at delivery
- Check if the delivery is complete
- Certification on the functionality of the device

3. Instructions

All deviations from the specifications that occurred during installation have to be recorded in this document.

In addition, all measures taken to eliminate the deviations have to be noted down as comments in the list of rectifications (LOR) on page 4.

If certain items in the report are not applicable, this has to be indicated in the table as „N/A“ (not applicable). Major sections that are not used have to be crossed out (diagonal line), marked „N/A“, dated and signed.

All required documents have to be completed by the end of the installation. The document has to be reviewed and approved by an authorized person. The review and approval have to be documented with signature and date (DD/MM/YYYY).

The tests have to be carried out in a suitable environment, as described in the user instruction of the device.

4. About this document

The information in this document is subject to change without prior notice. This document may not be used, reproduced or translated without written consent of KNAUER Wissenschaftliche Geräte GmbH. Depending on the customer's quality assurance system, the signed document either has to be filed in the device folder or scanned and stored in an electronic archive.

5. Device data

Device name		Product number	
Serial number		Order number	
Firmware version			
Installation location			

6. Customer and manufacturer data

	Customer	Manufacturer
Company		KNAUER Wissenschaftliche Geräte GmbH
Customer number		-
Contact person/agent		
Address		Hegauer Weg 38
Postal Code/City		14163 Berlin
Phone		+49 30 80 97 27 111
E-Mail		support@knauer.net

Installation Qualification (IQ) for a Device

7. Installation Qualification Tests

Test	Description	Specification	Passed	Failed	N/A	Comment/LOR No.
1	Identify the device.	The name on the device matches the name on the delivery order.				
2	Check the device for transport damage.	No transport damage is observed.				
3	Check the scope of delivery.	The scope of delivery matches the packing list and/or the delivery order.				
4	Check that the technical documentation provided is correct and complete (material documentation of wetted parts, calibration certificates etc.)	The documentation is correct and complete.				
5	Check that all equipment is properly and correctly labeled according to the delivery order and/or the labeling specifications document, if applicable.	The equipment is labeled correctly.				
6	Connect all loose parts (e.g. capillaries, tubings, measuring head) according to the user instructions.	The device is fully assembled and ready to use.				
7	Ensure that the installation site is suitable according to the user instructions.	The installation site matches the specifications in the user instructions.				
8	Connect the device to the power supply and switch it on.	The device starts (operating noise). The power LED or the display lights up.				

Installation Qualification (IQ) for a Device

8. List of rectifications (LOR)

LOR No.	Test No.	Type of deviation*	Description of the deviation	Action plan	Persons responsible	Due date	Date/signature

*Type of deviation:

A = acceptable (e.g. not a GMP-critical deviation)

N = not acceptable

Continuation of qualification activities into the next qualification phase is only possible when deviation is rectified.

T = temporarily acceptable

a) Release and use of the system is possible, even when the deviation is not rectified.

b) A continuation of qualification activities into the next qualification phase is possible, even when the deviation is not rectified

Installation Qualification (IQ) for a Device

9. List of changes to the document

Revision no.	Description of change	Additional information	Date/signature

Installation Qualification (IQ) for a Device

10. Certificate and approval

A KNAUER employee or an employee authorized by KNAUER has checked the device and performed all tests described in the IQ.

The IQ form has to be signed by an authorized person. The scope of the IQ meets the customer’s requirements.

The results of the IQ, any changes made as well as the IQ process have been documented in this form in writing. The users listed below were instructed and are familiar with how to operate the device. Both parties confirm that the IQ has been performed to the customer’s satisfaction by signing it.

10.1 Customer approval

Name	Function	Date	Signature

10.2 KNAUER agent approval

Name	Function	Date	Signature

11. Comments / recommendations

Science with Passion



Latest KNAUER instructions online:
www.knauer.net/library

KNAUER
Wissenschaftliche Geräte GmbH
Hegauer Weg 38
14163 Berlin

Phone: +49 30 809727-0
Fax: +49 30 8015010
E-Mail: info@knauer.net
Internet: www.knauer.net