

Azura

Valve Drive V 2.1S

Instructions



HPLC

Document No. V6860

Note: The contents of this user manual apply for the BlueShadow product. Please submit a request on any article numbers for BlueShadow.

Table of Contents

Note: For your own safety, read the manual and always observe the warnings and safety information on the device and in the manual.

Intended Use	6
Device Overview	6
Valves and Valve Drives	6
Front View	7
Rear View	7
Valve Types	8
2-Position Valves	8
Multiposition Valves	9
Valve Drives	10
Seals	10
Eluents	11
Scope of Delivery	12
Safety	12
Signal Words	14
Decontamination	14
Symbols and Signs	15
Installation	15
Contact Data	15
Transport	16
Operating Environment	16
Setup	17
Mounting the Valve onto the Valve Drive	17
Setting the Valve Mode	17
Screwing the Adapter Plate onto the Valve Drive	19
Screwing the Valve onto the Valve Drive	19
Installing the Sample Loop	20
Description for PEEK Sample Loop	20
Description for Stainless Steel Sample Loop	21
Inserting the Needle Seal	22

Connecting the Device to the Computer	23
Configuring the LAN Settings	23
Connecting the Cables	24
Configuring the Router	24
Integrating the LAN into a Company Network	25
Controlling Several Systems Separately in a LAN	25
Connecting the Remote Connector	25
GROUND	26
HOME	26
BIN 0 - 3	27
Binary Code	27
Ground	28
Operation	28
Operating with the Keypad	28
Operation with Chromatography Software	29
Switch On and Self Test	29
Setting the Valve Position	30
Injecting the Sample	30
Application Examples	31
Valve Positions	31
Valve Position <i>Load (L)</i>	31
Valve Position <i>Inject (I)</i>	32
Selecting the Column	33
Backflushing the Column	34
Backflushing the Precolumn	34
Functional Tests IQ and OQ	36
Troubleshooting	37
LAN	37
Error Messages	37
Maintenance and Care	38
Cleaning and Caring for the Device	38
Valve Assembly	38
Disassembling the Valve	39
Orientating the Rotor Seal in the Valve	41

Technical Data	41
Repeat Orders	42
Valve Drive and Accessories	42
Valves for Drives	42
Manual Valves	43
Power Cable	43
Wear Parts	44
Legal Information	44
Transport Damage	44
Warranty Conditions	44
Declaration of Conformity	45
Disposal	45
Index	46

To whom it may concern

In case you prefer a French language user manual for this product, submit your request including the corresponding serial number via email or fax to KNAUER:

- support@knauer.net
- +49 30 8015010

Thank you.

A qui que ce soit

Si jamais vous préféreriez un manuel en français pour ce produit contacter KNAUER par email ou par fax avec le no. de série:

- support@knauer.net
- +49 30 8015010

Merci beaucoup.

Intended Use

Note: Only use the device for applications that fall within the range of the intended use. Otherwise, the protective and safety equipment of the device could fail.

Description

2-position valves are used in the HPLC to bring in the sample from the sample loop in the pumps high pressure flow, so that the sample is transported to the column. The sample is brought into the sample loop with a syringe or a feed pump. Multiposition valves serve for fractionating, eluent selection, or sample selection.

2-position valves have 6 ports and 3 channels (6P/3C), multiposition valves have 1 channel always.

Operating Ranges

Among others, the device can be used for analytical or purification tasks.

Device Overview

Various types of valves with different operating modes allow the use of these valves for a variety of applications. It is important that valve drive and valve are compatible.

You can mount additional manual valves to an optional mounting bracket that can be fixed with screws on the AZURA modules or other devices. Find further information on our website www.knauer.net.

Valves and Valve Drives

Valves and valve drives are completely assembled and tested when they leave the factory.

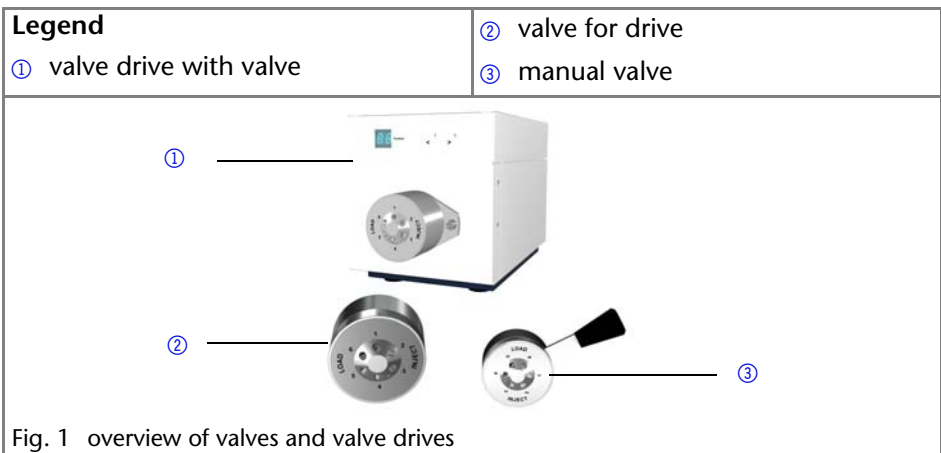

Front View

The valve drive has a display and a keypad.

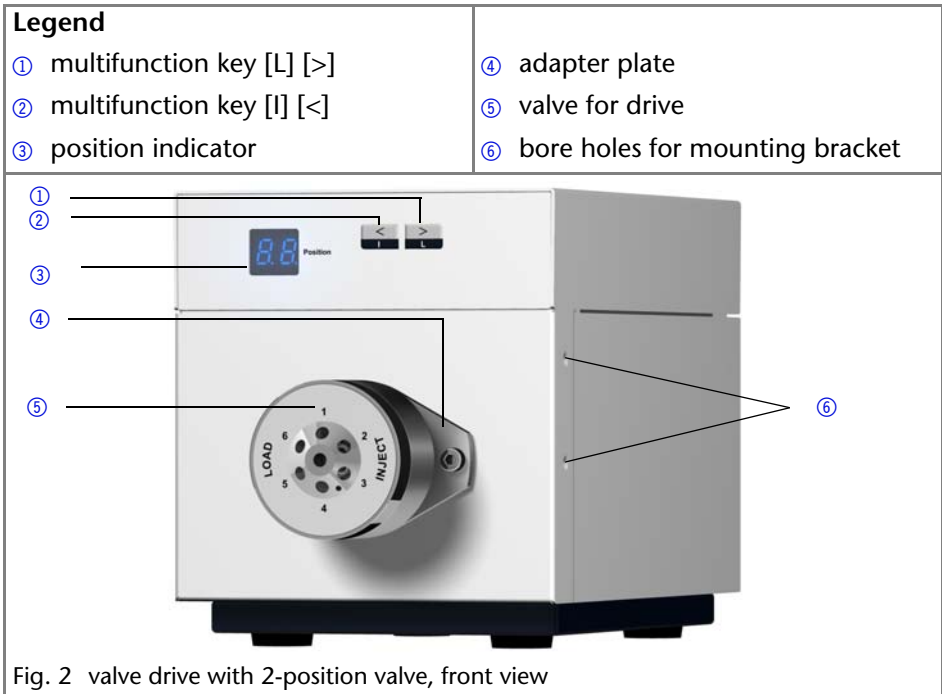

Rear View

On the rear of the device there are the power-connection bushing, ground for grounding the device, connections for external devices, symbols, warning signs and serial number.

External devices can be connected to the valve drive in three different ways:

- via remote connector
- via LAN connector within a network
- via RS-232 port

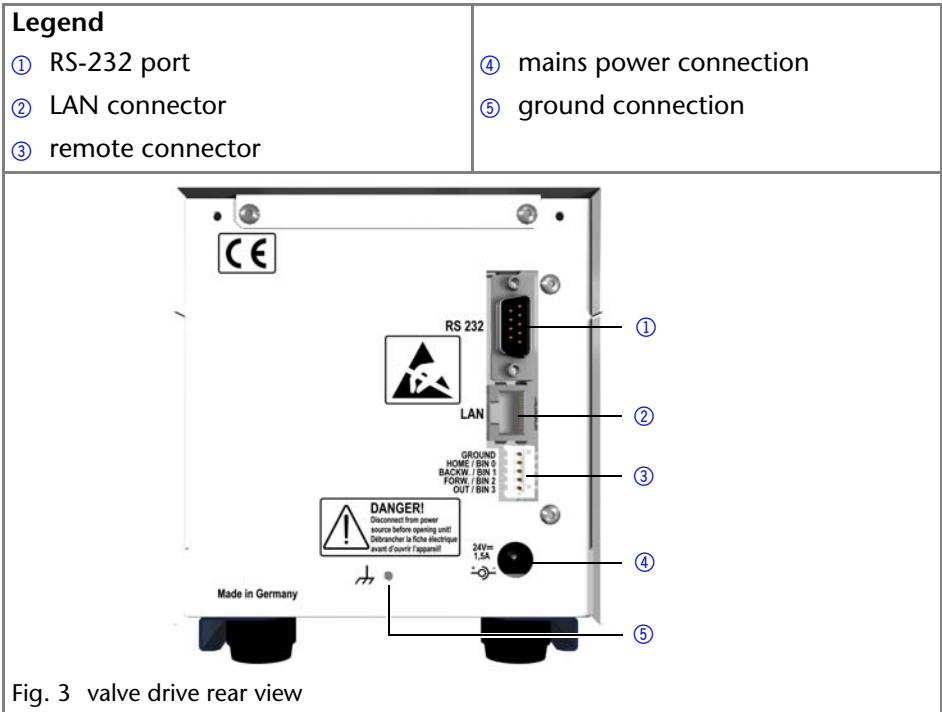

Valve Types

Generally, valves can be operated manually through a lever or electrically through the valve drive. Valves are available as 2-position valves or multiposition valves

Ports and channels are described by abbreviations to enable the identification of a specific valve. Example: 6P/3C = 2-position valve with 6 ports and 3 channels. In case of the multiposition valves, the input/output port is not counted.

Valves are available in stainless steel or PEEK and with 1/8" or 1/16" connectors.

2-Position Valves

2-position valves are used for injection, column switching, or column backflushing. In case of the 2-position valves, the rotary motions of the electrical valve are limited to 2 positions with a rotation angle of 60°.

You control 2-position valves either manually through a lever or electrically through the valve drive.

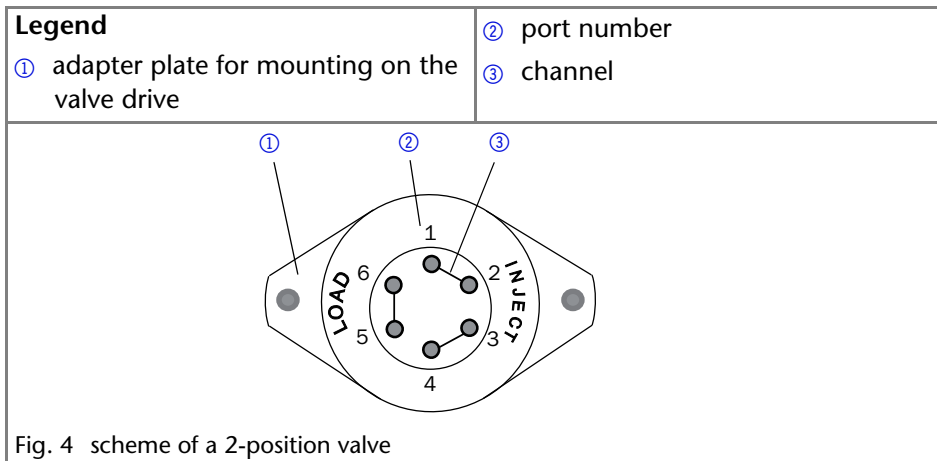

Reed Contact

The reed contact inside the 2-position valve causes a short-circuit contact. This short-circuit contact can be used as a start signal for the entire analytical system or as a start signal for a measurement with the detector. The function is to be set on the receiving device.

Multiposition Valves

Multiposition valves are used to switch fluid streams, e.g. the selection of eluents, columns or for fractionating of eluate. Multiposition valves are employed for fractionating if the form and the size of the fraction containers should be freely selectable. By combining up to 8 multiposition valves, up to 120 positions can be used for fractionating in applications in the preparative HPLC.

You control all multiposition valves electrically through a valve drive. 6P-multiposition valves can alternatively be controlled manually through a lever.

Legend

- ① port number
- ② connection between central port and ports 1-6
- ③ adapter plate for mounting on the valve drive

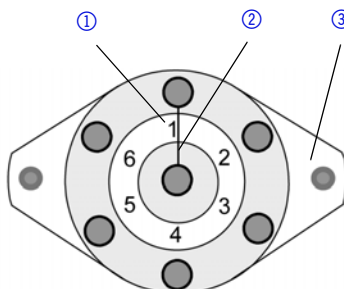

Fig. 5 scheme of a 6P-multiposition valve

Valve Drives

Valve drives are operated by a 24 V direct current motor. The valve drive and the valve come factory-set. You can change the valve mode by using the DIP switches (Dual-In-Line Package) on the bottom of the device.

By means of chromatography software or a cable for remote control, certain ports can be controlled directly on a valve.

- switch duration of the valve: 150 ms

There is a matching valve drive for every valve type. 6P/3C valves and 6P-multiposition valves operate on the same valve drive.

Note: Submit any questions about the possible combinations between valves and valve drives to the Technical Support of KNAUER.

All valve drives come with a ready-mounted valve (see "Repeat Orders" on page 42).

Seals

You are to use the seals according to their pressure resistance.

- For pressures < 50 bar you can use a bicone seal.
- For pressures > 50 bar you use *Dynaseal* for PEEK capillaries and screw fittings with ferrules for stainless steel or titanium capillaries.

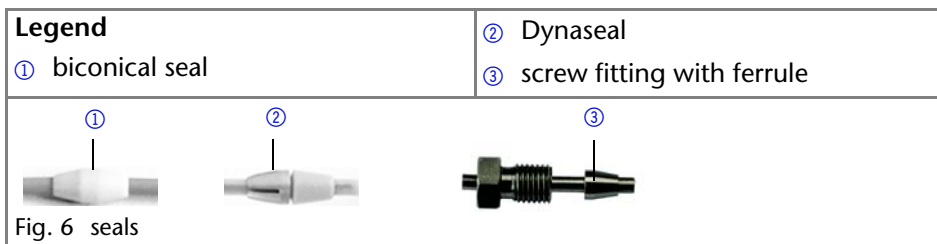

Eluents

Chemical resistance of a valve depends on the stator material and the rotor seal. Even small quantities of other substances, such as additives, modifiers, or salts can influence the durability of the materials.

Note: The list of selected solvents was compiled based on research in the pertinent literature and is only a recommendation. If there is any doubt, contact the Technical Support.

Material pH range	Suitable Eluents	Less Suitable Eluents	Unsuitable Eluents
POM-H-TF pH 3-14	<ul style="list-style-type: none"> ▪ ethanol ▪ ethylacetate ▪ hexane ▪ heptane ▪ isopropanol ▪ methanol 	<ul style="list-style-type: none"> ▪ acetone ▪ acetonitrile 	<ul style="list-style-type: none"> ▪ dichloromethane
PPS HPV	<ul style="list-style-type: none"> ▪ acetone ▪ dichloromethane ▪ ethanol ▪ ethylacetate ▪ hexane ▪ heptane ▪ isopropanol ▪ methanol ▪ 1 M NaOH ▪ 50 mM KH₂PO₄ 	<ul style="list-style-type: none"> ▪ acetonitrile ▪ strong bases ▪ oxydizing acids 	

Material pH range	Suitable Eluents	Less Suitable Eluents	Unsuitable Eluents
Vespel pH 0-10	<ul style="list-style-type: none"> ▪ acetone ▪ acetonitrile ▪ ethanol ▪ ethylacetate ▪ hexane ▪ heptane ▪ isopropanol ▪ methanol ▪ 50 mM KH₂PO₄ 		
Tefzel pH 0-14	<ul style="list-style-type: none"> ▪ acetonitrile ▪ ethanol ▪ ethylacetate ▪ hexane ▪ heptane ▪ isopropanol ▪ methanol 	<ul style="list-style-type: none"> ▪ dichloromethane 	<ul style="list-style-type: none"> ▪ acetone

Scope of Delivery

Note: Only use original parts and accessories made by KNAUER or a company authorized by KNAUER.

- V 2.1S valve + valve drive
- power adapter 24 V; max. 55 W + power cable
- user manual DE/EN
- Installation Qualification
- AZURA accessories kit

Safety

Professional Group

The user manual addresses persons who are qualified as chemical laboratory technicians or have completed comparable vocational training.

The following knowledge is required:

- Fundamental knowledge of liquid chromatography
- Knowledge regarding substances that are suitable only to a limited extent for use in liquid chromatography
- Knowledge regarding the health risks of chemicals

- Participation during an installation of a device or a training by the company KNAUER or an authorized company.

If you do not belong to this or a comparable professional group, you may not perform the work described in this user manual under any circumstances. In this case, please contact your superior.

Safety Equipment

When working with the device, take measures according to lab regulations and wear protective clothing:

- Safety glasses with side protection
- Protective gloves
- Lab coat

What must be taken into account?

- All safety instructions in the user manual
- The environmental, installation, and connection specifications in the user manual
- National and international regulations pertaining to laboratory work
- Original spare parts, tools, and solvents made or recommended by KNAUER
- Good Laboratory Practice (GLP)
- Accident prevention regulations published by the accident insurance companies for laboratory work
- Filtration of substances under analysis
- Use of inline filters
- Once they have been used, never re-use capillaries in other areas of the HPLC system.
- Only use a given PEEK fitting for one specific port and never re-use it for other ports. Always install new PEEK fittings on each separate port.
- Follow KNAUER or manufacturer's instructions on caring for the columns

More safety-relevant information is listed below:

- flammability: Organic solvents are highly flammable. Since capillaries can detach from their screw fittings and allow solvent to escape, it is prohibited to have any open flames near the analytical system.
- solvent tray: Risk of electrical shock or short circuit if liquids get into the device's interior. For this reason, place all bottles in a solvent tray.
- solvent lines: Install capillaries and tubing in such a way that liquids cannot get into the interior in case of a leak.
- leaks: Regularly check if any system components are leaking.
- power cable: Defective power cables are not to be used to connect the device and the power supply system.

- self-ignition point: Only use eluents that have a self-ignition point higher than 150 °C under normal ambient conditions.
- power strip: If several devices are connected to one power strip, always consider the maximum power consumption of each device.
- power supply: Only connect devices to voltage sources, whose voltage equals the device's voltage.
- toxicity: Organic eluents are toxic above a certain concentration. Ensure that work areas are always well-ventilated! Wear protective gloves and safety glasses when working on the device!

Where is use of the device prohibited?

Never use the system in potentially explosive atmospheres without appropriate protective equipment. For further information, contact the Technical Support of KNAUER.

Secure decommissioning

At any time, take the device completely out of operation by either switching off the power switch or by pulling the power plug.

Opening the Device

The device may be opened by the KNAUER Technical Support or any company authorized by KNAUER only.

Signal Words

Possible dangers related to the device are divided into personal and material damage in this user manual.



Lethal injuries will occur.



Serious or moderate injuries can occur.



Minor injuries can occur.



Device defects can occur.

Decontamination

Contamination of devices with toxic, infectious or radioactive substances poses a hazard for all persons during operation, repair, sale, and disposal of a device.



Life-threatening injuries

Health danger if getting in contact with toxic, infectious or radio-active substances.

- Before disposing of the device or sending it away for repair, you are required to decontaminate the device in a technically correct manner.





All contaminated devices must be properly decontaminated by a specialist company or the operating company before they can be recommissioned, repaired, sold, or disposed of. All materials or fluids used for decontamination must be collected separately and disposed of properly.

Decontamination Report

Devices without a completed Decontamination Report will not be repaired. If you would like to return a device to KNAUER, make sure to enclose a completed **Decontamination Report** with the device: <http://www.knauer.net/en/downloads/service.html>

Symbols and Signs

The following symbols and signs can be found on the device, in the chromatography software or in the user manual:

Symbol	Meaning
	Electric shock hazard
 <small>Electrostatic Discharge</small>	Electrostatic discharge hazard, damages to system, device, or components can occur.
	A device or system marked with CE fulfills the product specific requirements of European directives. This is confirmed in a Declaration of Conformity.
 <small>c us</small>	Testing seals in Canada and the USA at nationally recognized testing centers (NRTL). The certified device or system has successfully passed the quality and security tests.

Installation

This chapter describes all preparatory steps prior to the start-up. If you encounter difficulties during installation, contact the Technical Support.

Contact Data

Phone	+49 30 809727-111
Fax	+49 30 8015010
E-mail	support@knauer.net

Transport

Carefully prepare the device for transport or storage. If you want to return your device to KNAUER for repairs, enclose the Service Request Form which can be downloaded from our website.

Device Data

For a secure transport, note the weight and dimensions of the device (see Technical Data).



Bruising danger

Damage to the device by carrying or lifting it on protruding housing parts. The device may fall and thus cause injuries.

→ Lift the device on the side of the housing only.

Lifting

Clasp the device at its side panels and lift it out of the packaging. Do not hold onto front cover or leak tray.

Operating Environment

Only if the requirements for ambient conditions of the operating environment are met, can the intended use be ensured. Details on the operating conditions can be found in the Technical Data section.

A blue rectangular warning sign with a black border. The word "NOTICE" is written in white, bold, uppercase letters in the center of the rectangle.

NOTICE

Device defect

The device overheats at exposure to sunlight and insufficient air circulation. Device failures are very likely.

- Set up the device in such a way that it is protected against exposure to direct sunlight.
- Keep at least 15 cm clear at the rear and 5–10 cm at each side for air circulation.

Space Requirements

- At least 5 cm if another device is set up on one side
- At least 10 cm if further devices are set up on both sides
- At least 15 cm on the rear panel for the fan.
- Leave the power plug on the rear of the device accessible to be able to disconnect the device from the mains.

General requirements

- Position the device on a level and even surface.

- Protect the device against direct exposure to sunlight.
- Set up the device at a location not exposed to air drafts (A/C systems).
- Do not set up the device in the vicinity of other machines that cause floor vibrations.

Setup

Prerequisite

Check packaging for damage caused during transportation. If necessary, put forward any claim for damages to the carrier.

Tools

Utility knife



Bruising danger

Damage to the device by carrying or lifting it on protruding housing parts. The device may fall and thus cause injuries.

→ Lift the device on the side of the housing only.

Process

1. Set up the package in such a way that you can read the label. Using the utility knife, cut the adhesive tape and open the packaging.
2. Remove the foam insert. Take out the accessory kit and the manual.
3. Open the accessory kit and check the scope of delivery. In case any parts are missing, contact the Technical Support.
4. Clasp the device from below, lift it out of the packaging and place it on its feet. Do not hold onto the front cover.
5. Check the device for signs of damage that occurred during transport. In case you notice any damage, contact the Technical Support.
6. Place the device in its site of operation and remove protective foil.

Next steps

Store packaging and keep the included packing list for repeat orders.

Mounting the Valve onto the Valve Drive

All valve drives are delivered with a ready-mounted valve head. For repeat orders, the electrical valves are delivered with included adapter plate.

Setting the Valve Mode

You set the mode by means of the 4 DIP switches. The DIP switch is located on the bottom side of the device.

The valve drive for valves with 6 ports can be set for 6P/3C or 6P-multiposition valves.



Note: While setting the valve mode, switch the device off. Switch on the device after the configuration so that the changes become effective.

Switch Assignment

DIP	Function	Comment
1	specify valve type	-
2	specify valve position	-
3 and 4	set the port OUT/BIN 3 on the back of the device as input or output	set DIP switches 3 and 4 always opposite

Basic Functions of the DIP Switches

DIP	I/O	S6	S12	S16
1	ON	6P-multiposition valve	12P-multiposition valve	not permitted
	OFF	6P/3C	not permitted	16P-multiposition valve
2	ON	BIN 0-2 at 6P-multiposition valves	BIN 0-3	BIN 0-3
	OFF	RS-232, manual, Pos. 1; [I]; [L]	RS-232, manual, Pos. 1; [I]; [L]	RS-232, manual, Pos. 1; [I]; [L]
3	ON	output OUT/BIN 3	output OUT/BIN 3	output OUT/BIN 3
4	OFF			
3	OFF	not permitted	input OUT/BIN 3	input OUT/BIN 3
4	ON			

Combination Possibilities per Valve Type

Drive	Valve	Mode	DIP1	DIP2	DIP3	DIP4
V6	6P/3C	analog/RS-232	OFF	OFF	ON	OFF
	6P-multiposition valve	analog/RS-232	ON	OFF	ON	OFF
	6P-multiposition valve	binary	ON	ON	ON	OFF
V12	12P-multiposition valve	analog/RS-232	ON	OFF	ON	OFF
	12P-multiposition valve	binary	ON	ON	OFF	ON

Drive	Valve	Mode	DIP1	DIP2	DIP3	DIP4
V16	16P-multiposition valve	analog/RS-232	OFF	OFF	ON	OFF
	16P-multiposition valve	binary	OFF	ON	OFF	ON

Screwing the Adapter Plate onto the Valve Drive

Tools

Phillips screwdriver, size 3

1. Attach the adapter plate the right way around. The openings for the screws point to the front.
2. Using the screwdriver, screw on the 2 screws (M3).

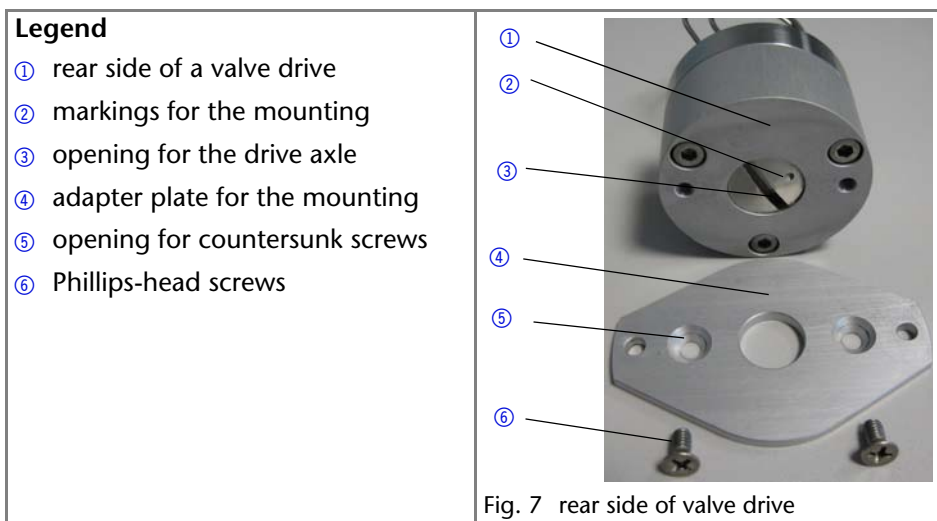

Screwing the Valve onto the Valve Drive

Prerequisites

- The DIP switch was set correctly.
- The valve drive matches the number of the valve ports.

Tools

Allen wrench, size 3

NOTICE

Device defect

Device damage due to blocked eluent flow.

- Check that the number of valve ports is identical with the type of valve drive (6V, 12V, 16V).

Note: The sample loop is not included with the delivery.

Process	Figure
<ol style="list-style-type: none"> 1. Switch the valve drive ① on. The initialization of the valve drive causes the markings on the drive axle to be on top. 2. Push the valve ③ onto the drive axle ②. The port 1 of the valve has to point up. 3. Using the wrench, screw the adapter plate to the valve drive (screws ④). 	 <p>Fig. 8 mounting the valve onto the valve drive</p>

Installing the Sample Loop

To install the sample loop, you have to select the right fittings and seals (see “Seals” on page 10). There are separate descriptions on how to install PEEK or stainless steel sample loops.

Description for PEEK Sample Loop

You find either shorter and longer or only longer fittings inside the accessories kit. Please note that you should always use a long fitting for the syringe port. In conclusion, you install the sample loop with long fittings on both ends or with a short fitting on one end and a long fitting on the other end.

Prerequisites

- The ends of the sample loop were cut straight at a right angle to the capillary axis.
- The Dynaseals are at hand.

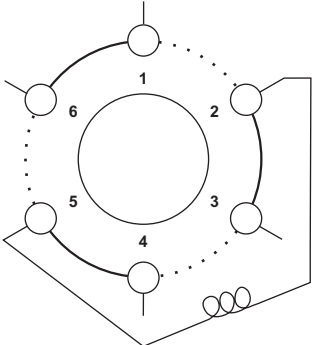
Process	Figure
<ol style="list-style-type: none"> 1. Insert one end of the sample loop into the fitting ① . 2. Firstly push the clamping ring ② onto the capillary, secondly the seal ring ③ . 3. Repeat the first steps on the other end of the capillary. 	 <p>Fig. 9 Dynaseal: fitting and seal</p>
<ol style="list-style-type: none"> 4. Fixate the first seal by screwing it into port 2. Afterwards unscrew again. 5. Fixate the second seal in port 5 and afterwards unscrew again. 6. Screw the sample loop evenly and simultaneously into port 2 and port 5. 	 <p>Fig. 10 scheme of an installed sample loop</p>

Description for Stainless Steel Sample Loop

Prerequisites

- The ends of the sample loop were cut straight at a right angle to the capillary axis.
- The screw fittings are at hand.

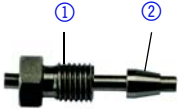
Process	Figure
<ol style="list-style-type: none"> 1. Insert one end of the sample loop into the screw fitting ① . 2. Push the ferrule ② onto the capillary so that the broader sight is opposite the screw fitting. 3. Repeat the first steps on the other end of the capillary. 	 <p>Fig. 11 screw fitting and ferrule</p>

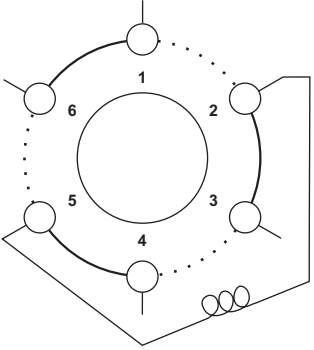
Process	Figure
<ol style="list-style-type: none"> 4. Fixate the first seal by screwing it into port 2. Afterwards unscrew again. 5. Fixate the second seal in port 5 and afterwards unscrew again. 6. Screw the sample loop evenly and simultaneously into port 2 and port 5. 	 <p>Fig. 12 scheme of an installed sample loop</p>

Inserting the Needle Seal

You fill the sample loop with a syringe or a feed pump. To do so, insert a needle seal into the syringe connection and fixate it with a biconical seal (see “Seals” on page 10). The needle seal for the syringe connection is available as PTFE or Teflon tube.

NOTICE

Component defect

Rotor-seal damage caused from non-fitting seal.

- Only reuse seals in one and the same location.
- Preferably use a new seal.

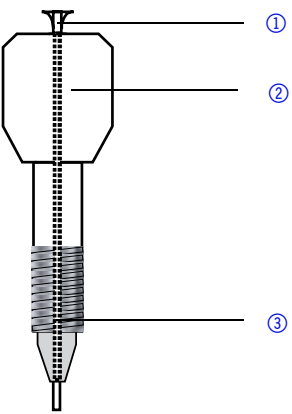
Process	Figure
<ol style="list-style-type: none"> 1. Insert the needle seal ① into the Dynaseal fitting ②. 2. Put the biconical seal ③ onto the needle seal. 3. Guide the needle into the needle seal, so that both ends fit equally. 4. Insert the needle seal and needle into the port 1 and screw in manually. The Dynaseal fitting sits adequately tight when you feel a resistance at pulling the needle. 	 <p>Fig. 13 scheme of syringe port</p>

Result

The 2-position valve is prepared for the injection of sample solution into the sample loop via a glass syringe with luer lock.

Connecting the Device to the Computer

This section describes how to set up an HPLC system in a local area network (LAN) and how a network administrator can integrate this LAN into your company network. The description applies to the operating system Windows and all conventional routers.

Note: To set up a LAN, we recommend to use a router. That means the following steps are required:

Process

1. On the computer, go to the control panel and check the LAN properties.
2. Hook up the router to the devices and the computer.
3. On the computer, configure the router to set up the network.
4. Install the chromatography software from the data storage device.
5. Switch on the device and run the chromatography software.

Configuring the LAN Settings

The LAN uses only one server (which is normally the router) from that the devices automatically receive their IP address.

Prerequisite

- In Windows, power saving, hibernation, standby, and screen saver must be deactivated.
- In case you use an USB-to-COM box, the option "Allow the computer to turn off this device to save power" in the devicemanager must be deactivated for all USB hosts.
- Only for Windows 7: For the network adapter, the option "Allow the computer to turn off this device to save power" in the Device Manager must be deactivated.

Process

1. In Windows 7 choose *Start* ⇒ *Control Panel* ⇒ *Network and Sharing Center*.
2. Double-click on *LAN Connection*.
3. Click on the button *Properties*.
4. Select *Internet Protocol version 4 (TCP/IPv4)*.
5. Click on the button *Properties*.
6. Check the settings in the tab *General*. The correct settings for the DHCP client are:
 - a) *Obtain IP address automatically*
 - b) *Obtain DNS server address automatically*

7. Click on the button *OK*.

Connecting the Cables

A router ③ has several LAN ports ② and one WAN port ④ that can be used to integrate the LAN into a wide area network (WAN), e.g. a company network or the Internet. In contrast, the LAN ports serve to set up a network from devices ① and a computer ⑤. To avoid interference, we recommend operating the HPLC system separately from the company network.

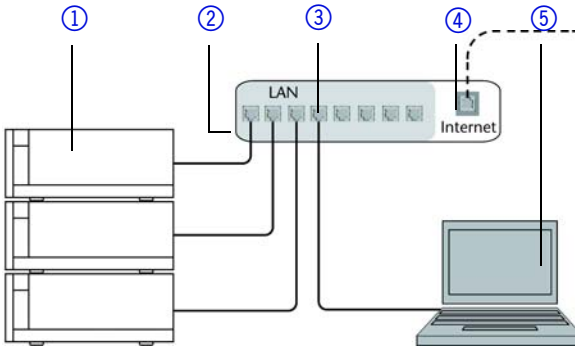

You will find patch cables for each device and the router in the accessories kit. To connect the router to a WAN, an additional patch cable is required, which is not supplied within the scope of delivery.

Prerequisite

- The computer has been switched off.
- There is a patch cable for each device and the computer.

Process

1. Use the patch cable to connect the router and the computer. Repeat this step to connect all devices.
2. Use the power supply to connect the router to the mains power system.

Configuring the Router

The router is preset at the factory. You will find a label at the bottom side of the router, on which IP address, user name, and password are printed. These information help to open the router configuration.

Process

1. To open the router configuration, start your Internet browser and enter the IP address (not for all routers).
2. Enter user name and password.
3. Configure the router as DHCP server.
4. In the router configuration, check the IP address range and make changes if necessary.

Result

Once the router has assigned IP addresses to all devices, the chromatography software can be used to remotely control the system.

Integrating the LAN into a Company Network

A network administrator can integrate the LAN into your company network. In this case you use the WAN port of the router.

Prerequisite

There is a patch cable for the connection.

Process

1. Check that the IP address range of the router and of the company network do not overlap.
2. In case of an overlap, change the IP address range of the router.
3. Use the patch cable to connect the router WAN port to the company network.
4. Restart all devices, including the computer.

Controlling Several Systems Separately in a LAN

Devices connected to a LAN communicate through ports, which are part of the IP address. If more than one HPLC system is connected to the same LAN and you plan on controlling them separately, you can use different ports to avoid interference. Therefore, the port number for each device must be changed and this same number must be entered into the device configuration of the chromatography software. We recommend to use the same port number for all devices in the same system.

Note: The port is set to 10001 at the factory. You must use the same numbers in the device configuration of the chromatography software as in the device, otherwise the connection fails.

Process

1. Find out port number and change it on the device.
2. Enter the port number in the chromatography software.

Result

The connection is established.

Connecting the Remote Connector

To control one device through another, you use the multi-pin connector. To use remote control, you have to connect cables to the terminal strip (both included with delivery). The single ports are used to exchange control signals.

Prerequisite

- The device has been turned off.

- The power plug has been pulled.

Tools

Depressor tool

NOTICE

Electronic defect

Connecting cables to the multi-pin connector of a switched on device causes a short circuit.

- Turn off the device before connecting cables.
- Pull the power plug.

NOTICE

Electronic defect

Electrostatic discharge can destroy the electronics.

- Wear a protective bracelet against electrostatic discharge and ground.

Process

1. Push the depressor tool ① into an upper small opening on the front of the terminal strip ③.
2. Lead the cable into the opening ② below the inserted depressor tool.
3. Remove the depressor tool.

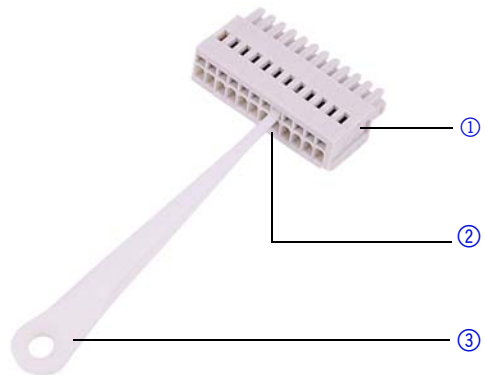

Next steps

Check if the cables are firmly attached. Push the terminal strip onto the multi-pin connector. Finish the installation. Then put the device into operation.

GROUND

Start and error signals are started to the ground connection without a current flow.

HOME

If the valve is controlled by *HOME*, it has priority over control via RS-232 or manual operation. As long as the switch-off signal is not canceled, the valve cannot be started. The indicator of the position flashes to indicate that the start of the valve is prevented by an external signal.

Signal	Explanation
GROUND	Ground connection for start and error signals
HOME/POS. 1	Connection for short circuit for creating a switch signal: <ul style="list-style-type: none"> ▪ Valve drive is set to position 1.
FORWARD/ LOADING	Connection for short circuit for creating a switch signal, example for output: <ul style="list-style-type: none"> ▪ LOADING ▪ Move to the next higher port of the valve, e.g. from position 2 to position 3
BACKWARD/ INJECTING	Connection for short circuit for creating a switch signal, example for output: <ul style="list-style-type: none"> ▪ INJECTING ▪ Move to the next lower port of the valve, e.g. from position 6 to position 5
OUT	Connection for short circuit (no current) <ul style="list-style-type: none"> ▪ INJECTING, port 1, low-impedance ▪ LOADING, port 2-6 or 2-16, high-impedance

BIN 0 - 3

If the DIP switches were set to binary operation, then the connections BIN 0 - BIN 2 are available as inputs. The output BIN 3 is active for the ports 1-6.

On the 12 port and 16 port valves, BIN 3 is defined as an input so that the ports 9-12 or 9-16 can be used.

Note

The binary input is inactive during the change of the valve port. This can be used to control further external devices.

Binary Code

A binary code is entered during binary control so that the valve can be set externally in the correct position (nominal position).

Prerequisites

The DIP switch of the device was set for the binary control.

Position	BIN 0 ($2^0=1$)	BIN 1 ($2^1=2$)	BIN 2 ($2^2=4$)	BIN 3 ($2^3=8$)	Result, binary
1	0	0	0	0	0
2	1	0	0	0	1
3	0	1	0	0	2
4	1	1	0	0	3

Position	BIN 0 ($2^0=1$)	BIN 1 ($2^1=2$)	BIN 2 ($2^2=4$)	BIN 3 ($2^3=8$)	Result, binary
5	0	0	1	0	4
6	1	0	1	0	5
7	0	1	1	0	6
8	1	1	1	0	7
9	0	0	0	1	8
10	1	0	0	1	9
11	0	1	0	1	10
12	1	1	0	1	11
13	0	0	1	1	12
14	1	0	1	1	13
15	0	1	1	1	14
16	1	1	1	1	15

Ground

NOTICE

Electronic defect

Electronic hazard when using an identically constructed power adapter from another manufacturer.

- Contact the Technical Support of KNAUER.
- Never connect the device to the power connection.

The ground connection for the valve drive has a designated hole with a thread M3 on the back of the device.

Note: If the supplied power adapter is used, then the ground connection remains unused.

Operation



You have several options to select one port with the valve drive:

- with chromatography software
- with the keypad
- with the Pin Header (see “Connecting the Remote Connector” on page 25)

Note: It is not possible to use 2 control methods simultaneously. Example: If the device is connected to the software, it cannot be controlled via Control Unit.

Operating with the Keypad

The keypad consists of 2 keys, which allow to operate the device.

Figure	Function
	<ul style="list-style-type: none"> ▪ setting the values ▪ scrolling through the menu
	injecting sample
	loading sample

Operation Arrow Keys

1. Hold down the left arrow key. Scroll through the menu using the right arrow key.
2. Let go of the left arrow key and, using both arrow keys, set the values.

Operation with Chromatography Software

To operate the device with software, you have to establish a connection between the LAN port and a computer. The devices are controlled with e. g. OpenLAB EZChrom edition, ChromGater or ClarityChrom.

You find a detailed description on the chromatography software in the corresponding user manual.

Switch On and Self Test

Prerequisites

Valve drive has been set up.

NOTICE

Device defect

Damage to the rotor seal located inside the valve.

→ Never start or operate the valve without fluid.

Process	Figure
<ol style="list-style-type: none"> 1. Connect the valve drive with the plug from the external power adapter. 2. Wait until the self test has been completed. 	 Fig. 14 display injection port

Result

After switching on the device, 18 is displayed on the display and the automatic self-test starts. After all tests have been successfully completed, 1 is displayed.

Next Steps

Set the valve position.

Setting the Valve Position

The multiposition valves have an internal forwarding function, e.g. from position 6 directly to position 1. Their switching radius is 360°, therefore they can be switched to any desired position by means of the arrow keys. The last setting is inherited. If several valves are switched in series, then all positions will be changed.

Note: The valve position can be changed during operation. The change takes effect immediately.

Process	Figure
<ol style="list-style-type: none"> 1. Use the arrow keys to set a value for the position. 2. Let go of the arrow key. 	 <p data-bbox="564 716 892 743">Fig. 15 possible display for V16</p>

Next Steps

Start the sample injection.

Injecting the Sample

Prerequisites

- The sample loop is mounted between the position 2 and 5 (see “Installing the Sample Loop” on page 20).
- The syringe port was mounted.
- The data acquisition was started.



NOTICE

Component defect

Valve damage when using pointed injection syringes.

→ Use only injection syringes with luer lock and flat-ground cannula.

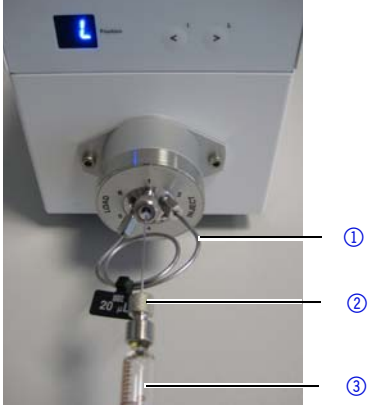
Process	Figure
<ol style="list-style-type: none"> 1. Press [L]. 	 <p data-bbox="564 1433 769 1460">Fig. 16 display load</p>

Process	Figure
<ol style="list-style-type: none"> 2. Fill the injection syringe ③ with eluent. Make sure that there are no air bubbles. 3. Insert the injection syringe into the syringe port ②. 4. Fill the sample loop ①. Leave the syringe connected. 	 <p>Fig. 17 injection syringe</p>
<ol style="list-style-type: none"> 5. Press [L]. 	 <p>Fig. 18 display inject</p>

Result

The sample is injected and measured. The syringe remains connected until the next injection.

Application Examples

This chapter describes possible applications for the different valve types. Of course there are also other applications possible which are not listed here.

Valve Positions

The eluent flows through the sample loop in opposite direction of the position load (see arrows in the figures).

1. The sample loop is filled by injecting the sample at port 1. The sample runs into the sample loop (port 2 and 5) and excessive sample is transported into the waste container through port 6.
2. The valve is switched from load to inject.
3. The pump (port 4) transports the sample to the column (port 3).
4. The eluent flows through the sample loop in opposite direction then during injection, see arrows in the figures.

Valve Position *Load* (L)

In the valve position *load* the sample is filled into the sample loop.

Legend

port 1: sample injection

port 2: sample loop

port 3: column

port 4: pump

port 5: sample loop

port 6: waste

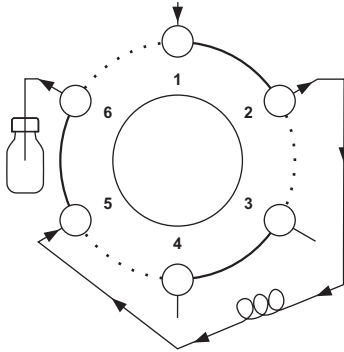

Fig. 19 valve position load

Valve Position Inject (I)

In the valve position *inject* the sample is transported to the column for separation.

Legend

port 1: sample injection

port 2: sample loop

port 3: column

port 4: pump

port 5: sample loop

port 6: waste

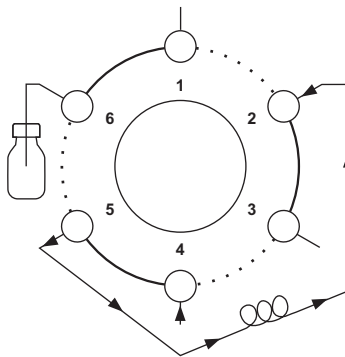

Fig. 20 valve position inject

Reed contact

The reed contact informs the analytical system whether the valve is positioned to 'LOAD' or 'INJECT'.

Selecting the Column

The column selection is used in chromatography, for example, in the following cases:

- Method development
- Usage of different columns in the same HPLC system
- Separation of the sample on the precolumn
- Separation of the sample components on different columns

Note: Make sure there is no pressure when switching between the columns so that the columns are not damaged.

Functional Principle

From the valve, the sample is transported through the channel 2->1 onto the column A ①. From port 5, the components of the sample are forwarded separately to the detector ②.

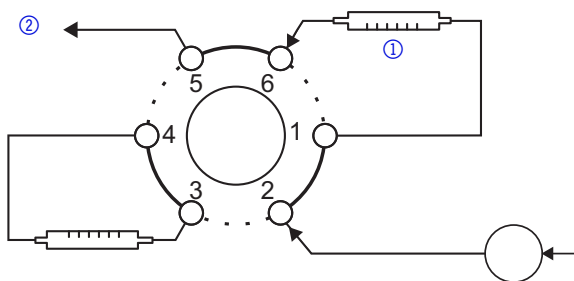

Fig. 21 column selection using column A

After switching the 2-position valve, the sample is transported through the channel 2->3 to the column B ①. From port 5, the components of the sample are forwarded separately to the detector ②.

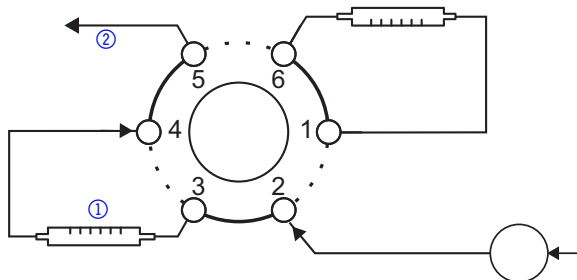

Fig. 22 column selection using column B

Backflushing the Column

The backflushing of a column is used, for example, in the following cases:

- analysis of heavily retarding substances
- optimization of analysis times
- flushing of a column

Note: The eluent flushes the column after switchover in opposite direction. Make sure there is no pressure when switching so that the column is not damaged.

Functional Principle

From the valve, the column ① is filled with sample through the channel 2->3. The quicker part of the substances is separated through the channels 6->1 and 5->4 and transported to the detector ②.

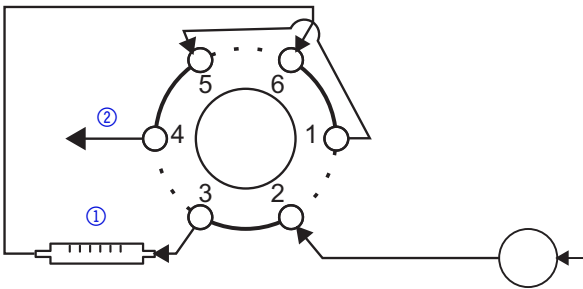

Fig. 23 backflushing - transport of the sample onto the column

After switching over the valve, heavily retarding substances are eluted in opposite direction from the column ① and are transported back to the detector ②.

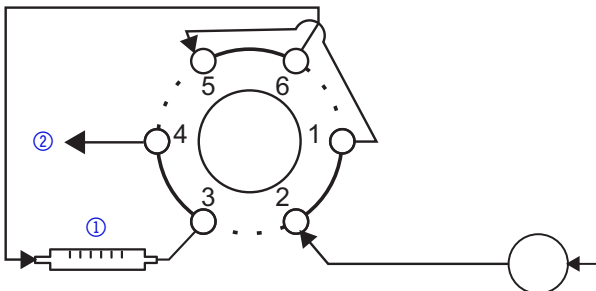

Fig. 24 backflushing of the column

Backflushing the Precolumn

The precolumn is used in chromatography, for example, in the following cases:

- preseparation or separation of heavily retarding substances

- protection of the column

Note: Precolumn and column are aligned in a row behind each other.

Note: The eluent flushes the precolumn after switchover in opposite direction.

Functional principle

From the valve, the precolumn ① is filled with sample through the channel 2->3. From the channel 6->1, the quickly dissolved substances on the column ② are separated while the heavily retarding substances remain in the precolumn.

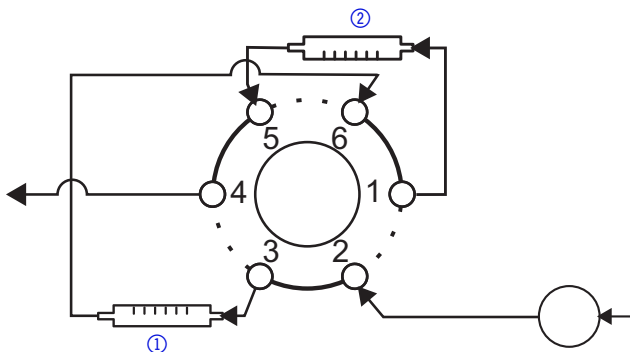

Fig. 25 use of precolumn

After switching over the valve, the late eluting substances are flushed back in opposite direction from the precolumn ① to the detector ②.

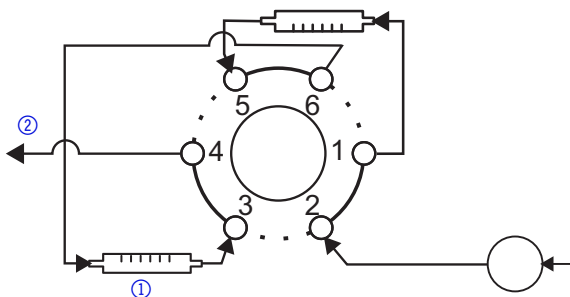

Fig. 26 backflushing of the precolumn

Functional Tests IQ and OQ

Installation Qualification (IQ)

The customer may request the Installation Qualification, which is free of charge. In case of a request, the Technical Support of KNAUER or from a provider authorized by KNAUER performs this functionality test during the installation. The Installation Qualification is a standardized document and includes the following:

- confirmation of flawless condition at delivery
- check if the delivery is complete
- certification on the functionality of the device

Operation Qualification (OQ)

The Operation Qualification includes an extensive functionality test according to KNAUER standard OQ documents. The Operation Qualification is a standardized document and free of charge. It is not part of the delivery, please contact the Technical Support in case of request.

The Operation Qualification includes the following:

- definition of customer requirements and acceptance terms
- documentation on device specifications
- device functionality check at installation site

Test Intervals

To make sure that the device operates within the specified range, you should test the device regularly. The test intervals are dependent on the usage of the device.

Execution



The test can be carried out either by the Technical Support of KNAUER or from a provider authorized by KNAUER.

Troubleshooting

LAN

Go through the following steps, in case no connection between the computer and the devices can be established. Check after each step if the problem is solved. If the problem cannot be located, call the Technical Support.

1. Check the status of the LAN connection in the Windows task bar:

-  Connected
-  Connection not established

If no connection was established, test the following:

- Is the router switched on?
 - Is the patch cable connected correctly to the router and the computer?
2. Check the router settings:
- Is the router set to DHCP server?
 - Is the IP address range sufficient for all the connected devices?
3. Check all connections:
- Are the patch cable connected to the LAN ports and not the WAN port?
 - Are all cable connections between devices and router correct?
 - Are the cables plugged in tightly?
4. If the router is integrated into a company network, pull out the patch cable from the WAN port.
- Can the devices communicate with the computer, even though the router is disconnected from the company network?
5. Turn off all devices, router, and computer. Firstly, turn on the router and secondly turn on the devices and the computer.
- Has this been successful?
6. Replace the patch cable to the device with that no connection could be established.
- Has this been successful?
7. Make sure that the IP port of the device matches the port in the chromatography software.

Error Messages

The display shows the status of the error. To renew components, you need to disassemble the valve (see “Disassembling the Valve” on page 39).

Display	Cause Of the Fault	Solution
E0	Setting the position of the valve was not changed.	Replace the rotor seals of the valve or replace the motor drive unit.
E1	Value of the motor current is too high.	Replace the rotor seals of the valve.
E2	Change from one valve position to the next takes too long.	Replace the rotor seals of the valve.
E3	Switch position of DIP 3 and 4 are not correct.	Correct DIP switch 3 and 4.
E4	Valve position 1 is not recognized.	Readjust sensor board.
E5	Switch position of DIP 1 and 2 are not correct.	Correct DIP switch 1 and 2.
	Binary code is not correct.	Check if valve setting (DIP switches) is correct,, then send the correct position parameter (binary code).
E6	Memory error	Switch the device off and on again.

Note: If it is not possible to rectify the fault based on this list, then contact the Technical Support.

Maintenance and Care

Cleaning and Caring for the Device

NOTICE

Device defect

Intruding liquids can cause damage to the device.

- Place solvent bottles next to the device or in a solvent tray.
- Moisten the cleaning cloth only slightly.

All smooth surfaces of the device can be cleaned with a mild, commercially available cleaning solution, or with isopropanol.

Valve Assembly

The valve contains a rotor in its housing. With disk springs, the rotor creates a certain pressure stability.

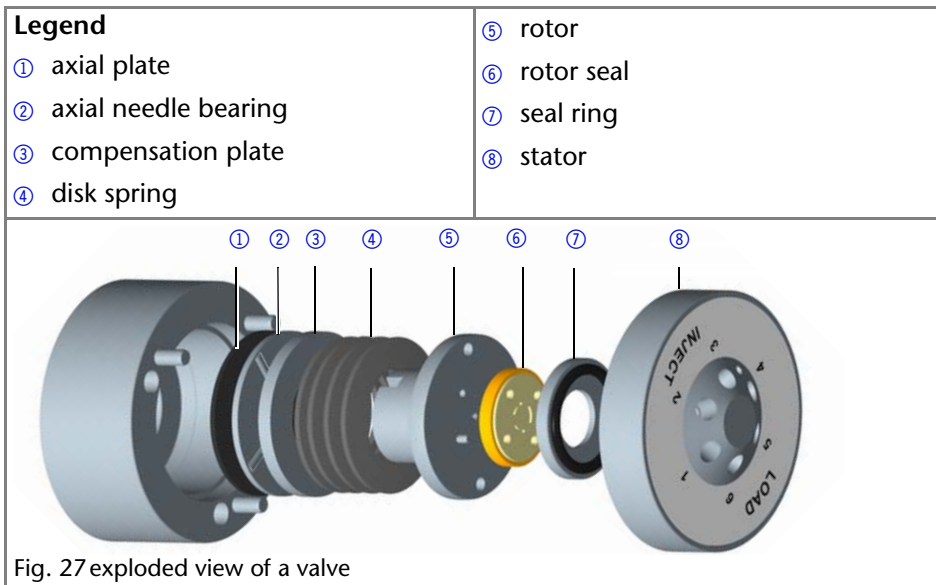

Disassembling the Valve

During assembly, make sure the rotor seal is in the right position and installed properly, because otherwise there may be a mix-up of the channels or clogging may occur.

Tools

Allen screwdriver, size 3

Note: During disassembly, make sure to mark the position of the rotor seal on the cylinder pins to make the assembly of the valve easier.

Procedure

1. Loosen the 3 screws ① of the valve alternately with a screwdriver (M3). Hold the housing of valve together so that the individual parts do not fall out.
2. Take off the top part.

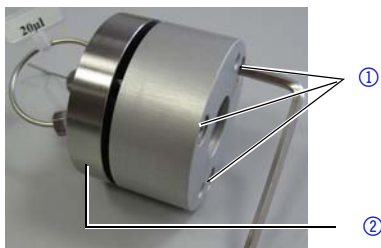

Procedure

3. The cylinder pins ③ and the rotor seal ④ become visible.

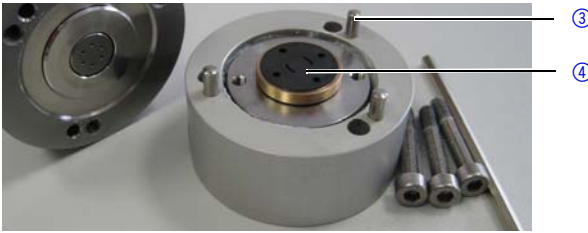

4. Remove the rotor seal ⑤ and deposit in the correct orientation. Mark position and installation position of the rotor seal.



5. Hold the inner components and turn over the bottom part in order to deposit the inner parts orderly.
Rotor plate with cylinder pins ⑥, 4 disk springs (2 pairs) ⑦, rotor seal ⑧, several sealing disks ⑨ inside the valve.

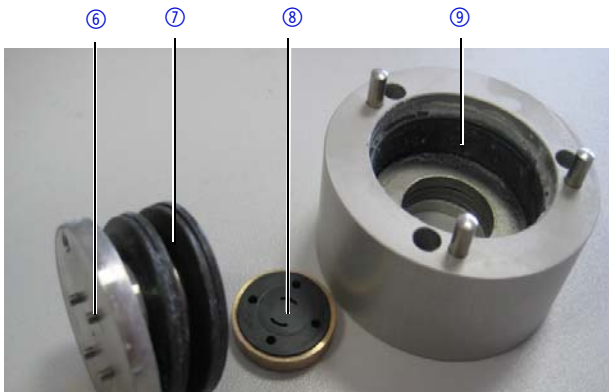

Next Steps

Pay attention to the alignment of the rotor seal in the valve during reassembly.

Orientating the Rotor Seal in the Valve

Valve Type	Position Of Rotor Seal During Installation
multiposition valve ① rotor ② marking ③ cylinder pins ④ rotor with seal	<p>Fig. 28 multiposition valve: position of the rotor seal</p>
2-position valves	<p>Fig. 29 2-position valve: position of the rotor seal</p>

Technical Data

Ambient Conditions

temperature range	4 – 40 °C; 39.2 – 104 °F
air humidity	below 90 % humidity (non-condensing)
height above sea level	maximum 2000 meters

Valve Drive

control	LAN, RS-232, keypad
dimensions (without valve)	121 x 129,1 x 187,2 mm (W x H x D)
weight	1.86 kg
display	LCD
power supply	power adapter 24 V DC, 60 W

Valve for Valve Drive

fitting	PEEK 10/32; 1/16" DYNASEAL; 1/16"; 1/8"
switch duration of the valve	approx. 300 ms; via reed contact

seals	rotor seals made of VESPEL, TEFZEL, POM-H-TF or ETFE
weight	300 g (valve)
diameter valve	47.5 mm

Manual Valves

weight	356 g (2-position valve)
diameter valve	47.5 mm

Repeat Orders

Valve Drive and Accessories

	Name	Order No
	valve drive V 2.1S, V6	AWA10
	valve drive V 2.1S, V12	AWA20
	valve drive V 2.1S, V16	AWA30
6V	valve drive with 6P/3C valve, PEEK, 1/16"	AWA10AC
	valve drive with 6P/3C valve, SS, 1/8"	AWA10AD
	valve drive with 6P/3C valve, PEEK, 1/8"	AWA10AE
	valve drive with 6P multiposition valve, PEEK, 1/16"	AWA10BB
	valve drive with 6P multiposition valve, SS, 1/8"	AWA10BC
	valve drive with 6P multiposition valve, PEEK, 1/8"	AWA10BD
	valve drive with 6P/3C valve, SS, 1/16", 400 bar	AWA11CA
	valve drive with 6P multiposition valve, SS, 1/16", 400 bar	AWA11DA
12V	Valve drive with 12P multiposition valve, SS, 1/8"	AWA20BG
16V	Valve drive with 16P multiposition valve, SS, 1/16"	AWA30BH
	AZURA accessories kit	FZA01
	V 2.1S accessories kit	FWA
	user manual DE/EN	V6860

Valves for Drives

Name	Order No
6P/3C valve, 1/16", SS, with accessories	A1369
6P/3C valve, 1/16", SS, 400 bar, with accessories	AWC26BC
6P/3C valve, 1/16", PEEK, with accessories	A1370V1

Name	Order No
6P/3C valve, 1/8", SS, with accessories	A1371
6P/3C valve, 1/8", PEEK, with accessories	A1372
6P multiposition valve, 1/16", SS, 400 bar, with accessories	AVR26BC
6P multiposition valve, 1/16", PEEK, with accessories	A1374V1
6P multiposition valve, 1/8", SS, with accessories	A1375
6P multiposition valve, 1/8", PEEK, with accessories	A1376V1
12P multiposition valve, 1/8", SS, POM-H-TF seal, with accessories	A1378
16P multiposition valve, 1/16", SS, 50 bar, with accessories	A1379

Manual Valves

Name	Order No
6P/3C injection valve, 1/16", SS, with accessories	A1357
6P/3C injection valve, 1/16", SS, 400 bar, with accessories	AVI26BC
6P/3C injection valve, 1/16", PEEK, with accessories	A1358V1
6P/3C injection valve, 1/8", SS, with accessories	A1359
6P/3C injection valve, 1/8", PEEK, with accessories	A1360V1
6P multiposition valve, 1/16", SS, with accessories	A1361
6P multiposition valve, 1/16", SS, 400 bar, with accessories	AVV26BC
6P multiposition valve, 1/8", SS, with accessories	A1363

Power Cable

Name	Order No
power cable for Germany	M1642
power cable for England	M1278
power cable for the USA	M1651

Wear Parts

Name	Order No
rotor seal 6P multiposition valve, 1/16", Vespel	A0611
rotor seal 6P multiposition valve, 0.3 mm bore size, Vespel	A0611.1
rotor seal 6P multiposition valve, 1/16", Tefzel	A1580
rotor seal 6P multiposition valve, 1/8", Vespel	A1581
rotor seal 6P multiposition valve, 1/8", Tefzel	A1582
rotor seal 6P multiposition valve, 1/16"-1/8", Vespel	A0880
rotor seal 6P multiposition valve, 1/16", 0.3 mm bore size, Vespel	A0880.1
rotor seal 6P multiposition valve, 1/16", Tefzel	A1586
rotor seal 6P multiposition valve, 1/16"-1/8", PPS HPV	A15861
rotor seal 2-position valve, 1/16", Tefzel	A1580
rotor seal 2-position valve, 1/16", PPS HPV	A15801
rotor seal 12P multiposition valve, 1/8", POM-H-TF	A1587
rotor seal 12P multiposition valve, 1/8", ETFE	A1587V1
rotor seal 16P multiposition valve, 1/16", POM-H-TF	A1588
reed contact	G0365
magnetic core	M0528
needle seal, 1/16"	P0653
needle seal, 1/8"	P0955

Legal Information

Transport Damage

The packaging of our devices provides the best possible protection against transport damage. Check the devices for signs of transport damage. In case you notice damages, contact the Technical Support and the forwarder company within three workdays.

Warranty Conditions

The factory warranty for the device is stipulated by contract. During the warranty period, any components with material or design-related defects will be replaced or repaired by the manufacturer free of charge. Please connect to our website for further information on terms and conditions.

All warranty claims shall expire in the event that any unauthorized changes are made to the device. This warranty also excludes the following:

- accidental or willful damage

- damage or errors caused by third parties that are not contractually related to the manufacturer at the time the damage occurs
- wear parts, fuses, glass parts, columns, light sources, cuvettes and other optical components
- damage caused by negligence or improper operation of the device and damage caused by clogged capillary
- packaging and transport damage

In the event of device malfunctions, directly contact the manufacturer.

KNAUER Wissenschaftliche Geräte GmbH

Hegauer Weg 38

14163 Berlin, Germany

Phone: +49 30 809727-111

Telefax: +49 30 8015010

e-mail: info@knauer.net

Internet: www.knauer.net

Declaration of Conformity

The Declaration of Conformity is part of the delivery and accompanies the product as a separate document.

Disposal

Hand in old devices or disassembled old components at a certified waste facility, where they will be disposed of properly.

AVV Marking in Germany

According to the German "Abfallverzeichnisverordnung" (AVV) (January, 2001), old devices manufactured by KNAUER are marked as waste electrical and electronic equipment: 160214.

WEEE Registration

KNAUER as a company is registered by the WEEE number DE 34642789 in the German "Elektroaltgeräteregister" (EAR). The number belongs to category 8 and 9, which, among others, comprise laboratory equipment.

All distributors and importers are responsible for the disposal of old devices, as defined by the WEEE directive. End-users can send their old devices manufactured by KNAUER back to the distributor, the importer, or the company free of charge, but would be charged for the disposal.

Solvents and Other Operating Materials

All solvents and other operating materials must be collected separately and disposed of properly.

All wetted components of a device, e. g. flow cells of detectors or pump heads and pressure sensors for pumps, have to be flushed first with isopropanol and then with water before being maintained, disassembled or disposed.

Index

Numerics

- 2-position valves 6, 8, 33
 - control 8
 - needle seal 23
 - scheme 9

A

- accessories 12
- adapter plate 17, 19
- additives 11
- ambient conditions 16, 41
- application examples 31
- arrow keys 29
- AVV marking 45

B

- biconical seal 10
- binary code 27

C

- column
 - backflush 34
 - select 33
- computer 23
- contamination 14, 15
- control
 - 2-position valve 8
 - binary 27
 - multiposition valve 9

D

- decontamination 14
- delivery 12
- DIP switch 10, 17
- disk spring 39, 40
- disposal 14, 15
- Dynaseal 10

E

- eluent list 11

F

- front cover 17

G

- ground 28

I

- inject 32
- installation
 - adapter plate 19
 - site 16
 - valves to valve drive 19
- IQ 36

K

- keypad 28
 - arrow keys 29
 - operation 29

L

- label 17
- LAN
 - port 25
 - problems 37
 - router 24
 - settings 23
 - setup 24
- leak 13
- load 32

M

- modifiers 11
- multiposition valves 6, 9, 30
 - control 9
 - scheme 10

N

- needle seal 44
 - insert 22

scheme 22

O

operating environment 16

operation

arrow keys 29

keypad 29

operating range 6

OQ 36

P

packing list 17

port (LAN) 25

power

cable 43

disconnect 16

line voltage 17

plug 16

supply 17

power cable 13

power strip 14

power supply 14

precolumn 34

professional group 12

R

reed contact 9, 44

remote connector 8

repair 14, 15

resistance 11

rotor seal 40, 44

align 41

position 39

router (LAN) 24

S

safety equipment 13

salts 11

sample loop 6, 20

fill 30

install 20

PEEK 20

scheme 21

stainless steel 21

scope of delivery 17

seal 10, 39

self test 29

setup 17

software 23, 29

solvent

flammability 13

line 13

self-ignition point 14

tray 13

space requirements 16

spare parts 12

stator 11, 39

switch on 29

syringe 22

T

test

Installation Qualification 36

Operation Qualification 36

transport damage 44

troubleshooting

error messages 37

LAN 37

V

valve 6

disassembly 39

exploded view 39

figure 6

individual parts 39

mount 17

position inject 32

position load 32

screw onto 19

set mode 17

set position 30

valve drive 6, 10

48

Index

mode 17

view 39

front 7

rear 7

W

warranty 44

Science Together



Latest KNAUER instructions online:
<https://www.knauer.net/en/Support/User-manuals>

© KNAUER 2018

KNAUER
Wissenschaftliche Geräte GmbH
Hegauer Weg 38
14163 Berlin

Phone: +49 30 809727-0
Fax: +49 30 8015010
E-Mail: info@knauer.net
Internet: www.knauer.net